

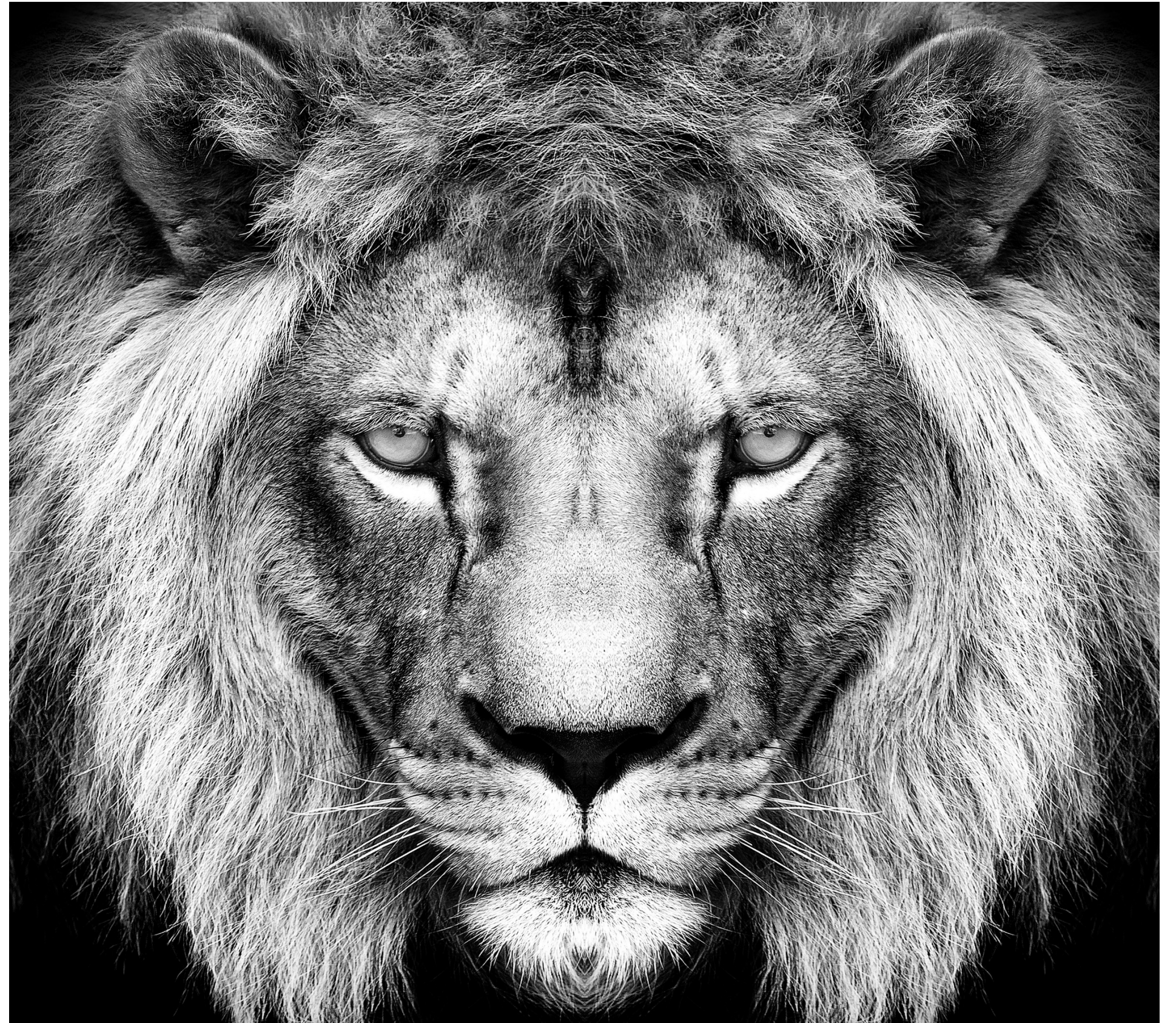

# How to print on Aluminum Composite panels

This document will explain you how to print on different types of aluminum composite panels, including white and other finishes.



# How to print on aluminum composite panels

## What you will need

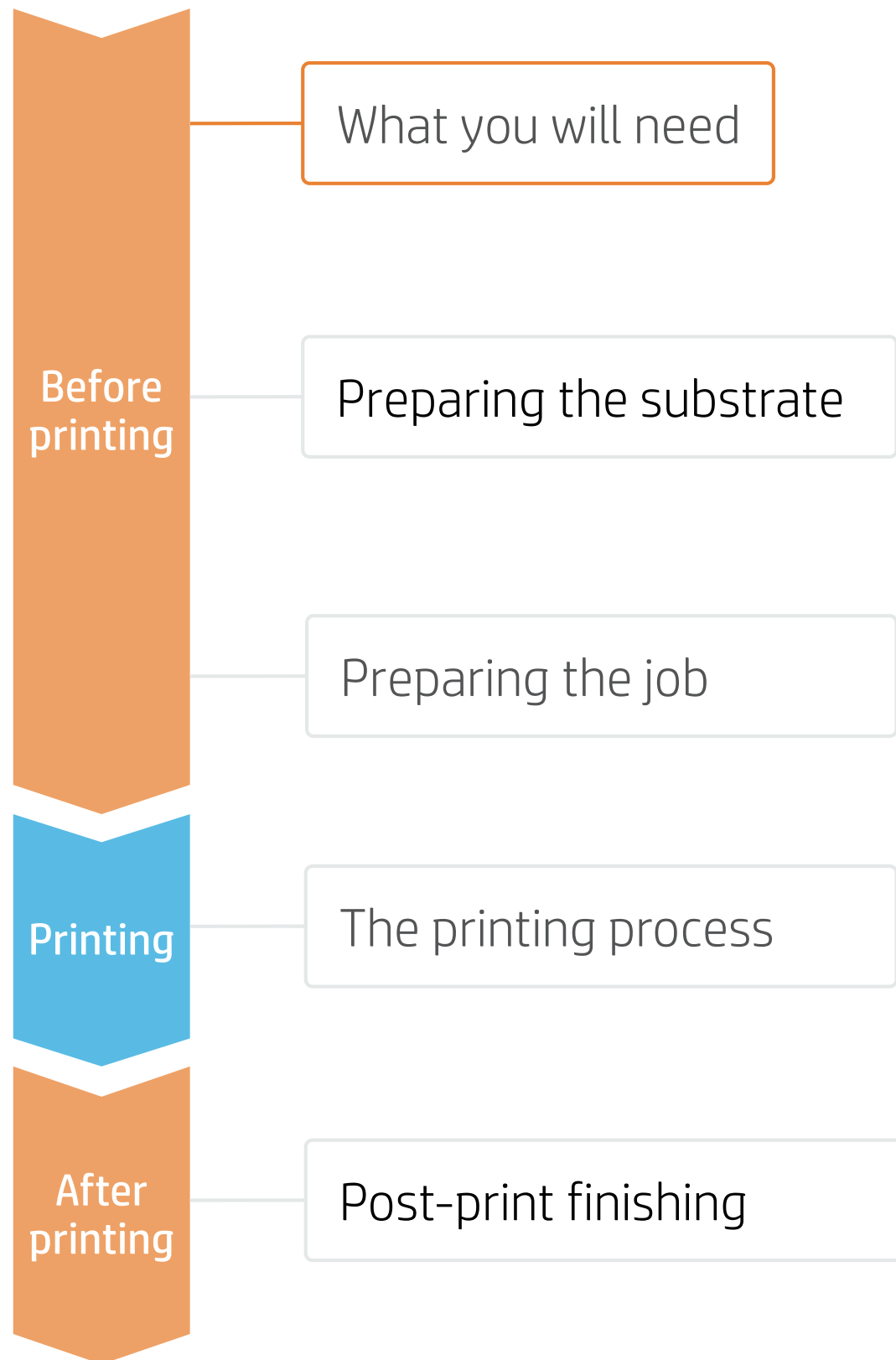

Aluminum composite panels

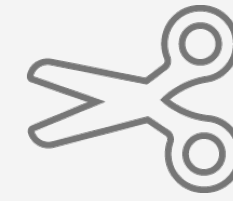

Cutting device

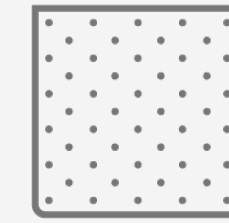

Clean Cloth



Gloves

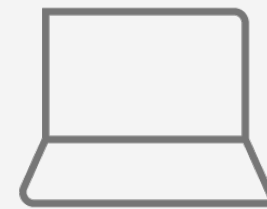

SW tools (RIP, image editor, etc.)

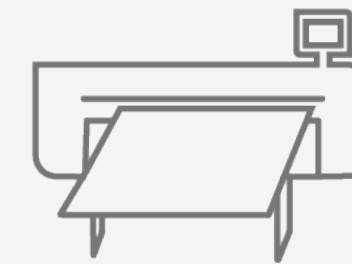

HP Latex R Series Printer



Isopropyl Alcohol (optional)

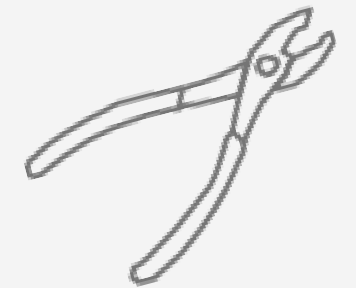

Pliers (optional)

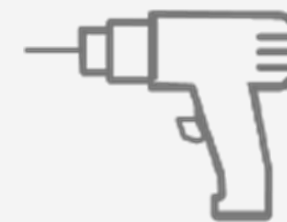

Drill and drill bits for use with metal (optional)

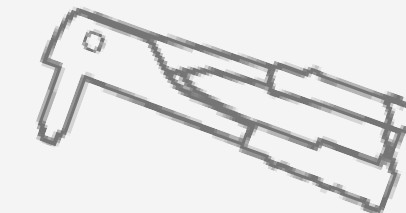

Rivets and rivet gun (optional)

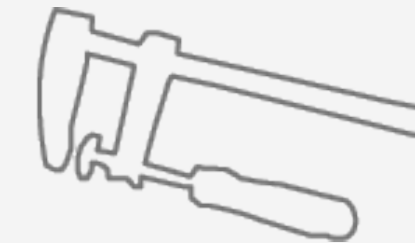

Joiner clamps (optional)

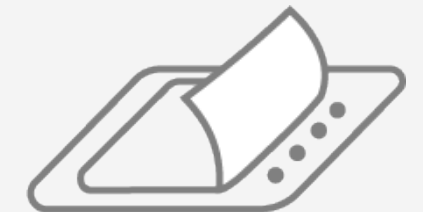

Film laminator (optional)



Liquid laminant (optional)

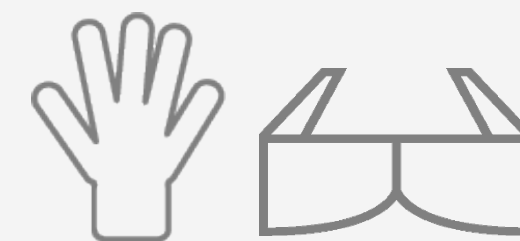

Protective gloves and goggles (liquid lamination optional)

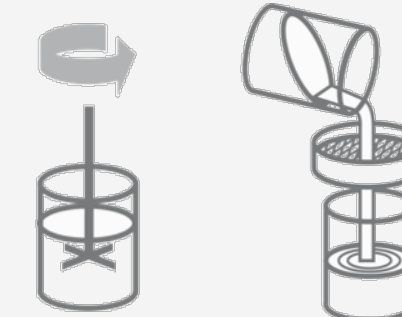

Spray gun application tools: mixer, filter, spray gun (optional)



# How to print on aluminum composite panels



## Preparing the substrate

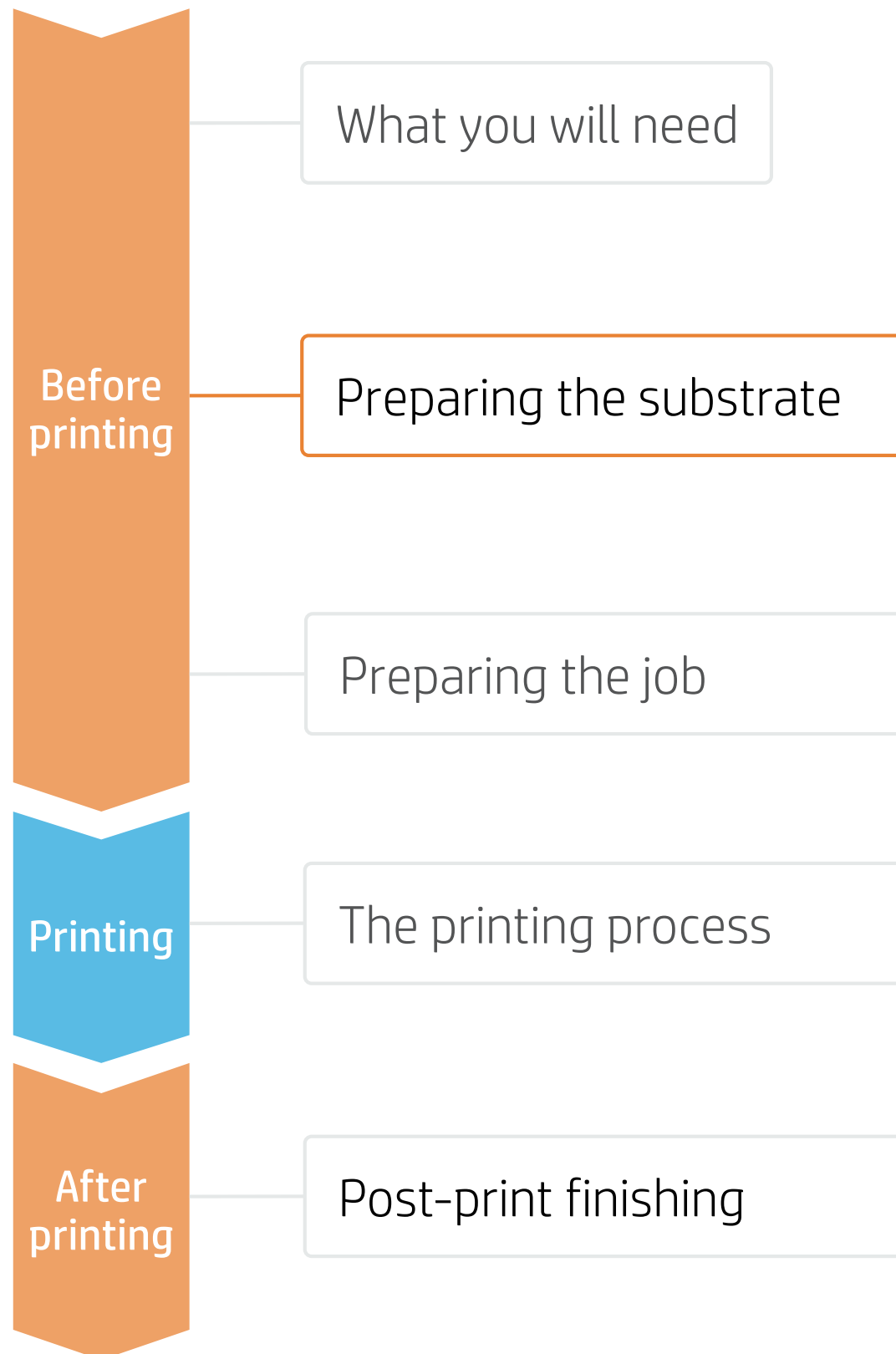

### 1. Ensure panel flatness

Ensure the substrate is flat and there are no damaged corners, edges or ends.

**TIP:** If the edges are bent, they should be flattened (with pliers, for example) before loading the sheet.

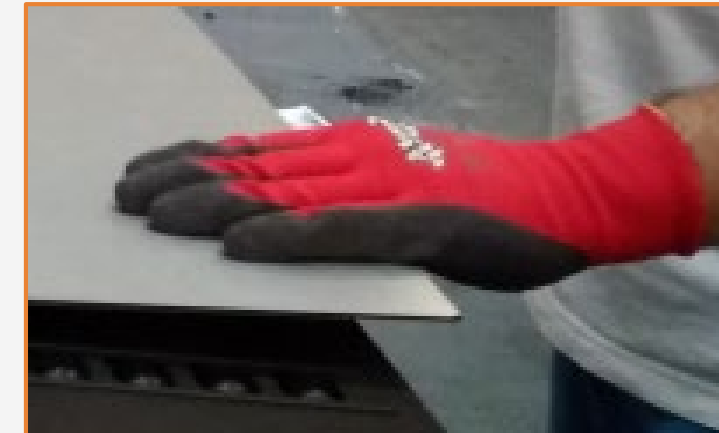

### 2. Substrate handling

Handle the samples carefully. It is recommended to use gloves to prevent cuts, and also to avoid fingerprints being left on the surface. Be aware that if the sample is scratched before printing, the scratch will be visible after printing.



### 3. Cut

Cut the sample to the desired size using a device (table saw, cutting table...).

**NOTE:** This process can also be done after the job is printed.



### 4. Remove the Liner

If the substrate has a protective film, peel it off from the print surface, leaving the other side protected until finishing, or installation of the finished graphic.



### 5. Clean

After the protective film is removed, dust particles may adhere to the print surface. Remove any dust particles by wiping the surface with an anti-static cloth.

**TIP:** If an anti-static cloth is not available, use a 90% Isopropyl Alcohol / 10% water solution with a lint free cloth and wipe the print surface. Let it dry before printing.

# How to print on aluminum composite panels



## Preparing the job

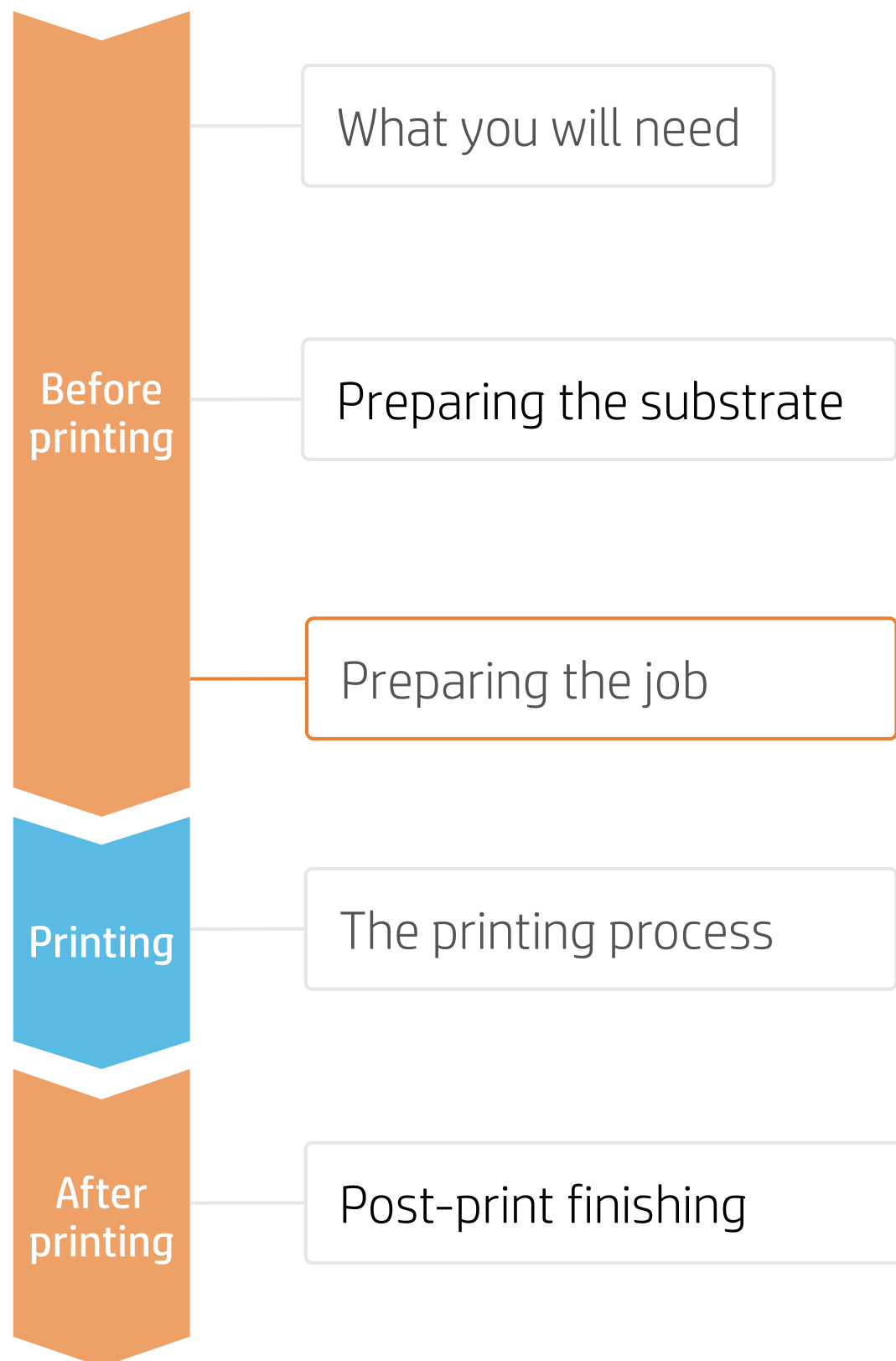

Make your decision based on the type of aluminum panel being used:

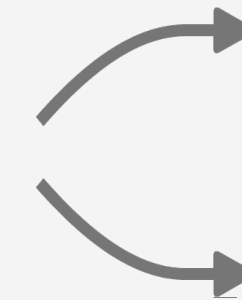

White (underflood) mode



Color mode and White (spot) mode

**TIP:** Using the white (underflood) mode provides the only way to ensure **good color accuracy on non-white panels**. However, the aluminum texture of brushed panels will be less evident than when using Color or White (spot) modes.

**NOTE:** To **work with either type of White mode**, please refer to the cookbook “How to print on White.”

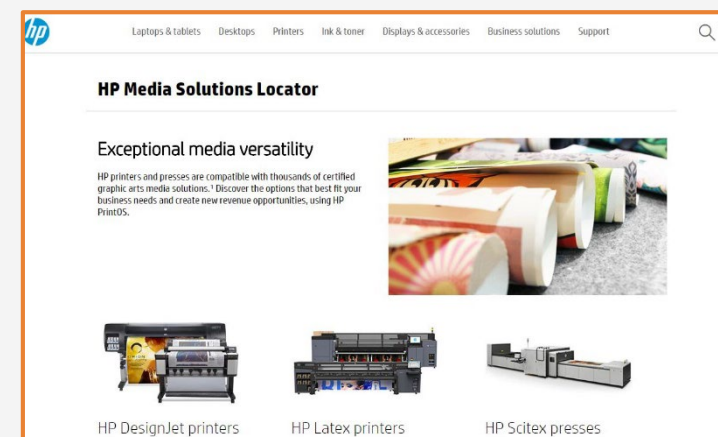

## Aluminum Composite media presets

Many Aluminum Composite Panel substrates have been tested at HP. In some cases, a substrate preset may already be available for downloading. Visit: <https://www.printos.com/ml/#/homeMediaLocator>

We recommend downloading and installing it on your printer and RIP.

If there is no preset for the specific substrate being used, the “Generic Aluminum Composite Panel” preset may be a good starting point.

# How to print on aluminum composite panels



## The printing process

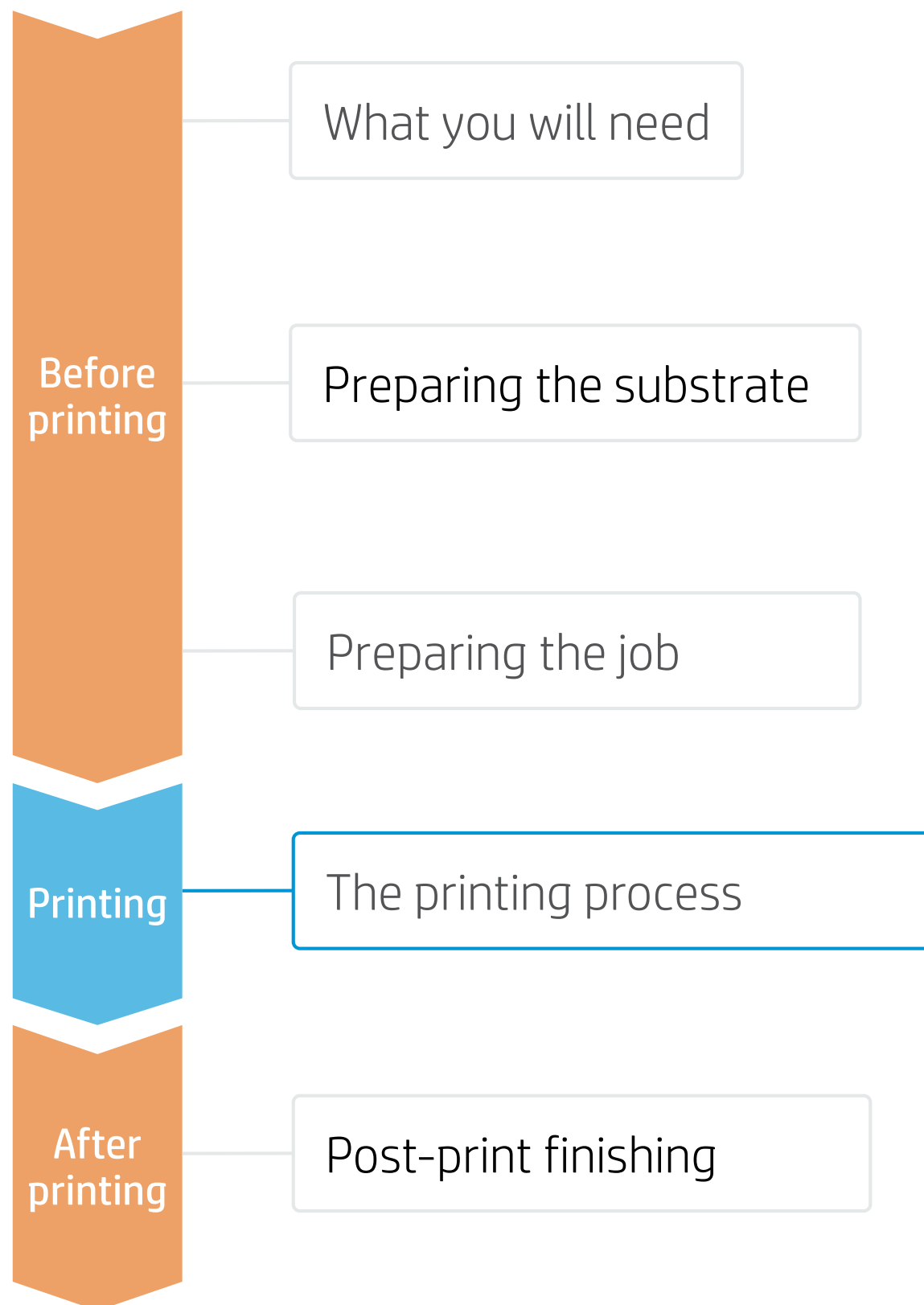

1. Rip the artwork after selecting the corresponding substrate preset and print mode for the aluminum panel. Send the output to the printer nest.
2. Load the substrate on the printer as **Aluminum Composite > Generic Aluminum Composite Panel** (or using a specific preset previously downloaded).
3. Follow the loading process.
4. Select the RIPped job and drag it to the printer queue.

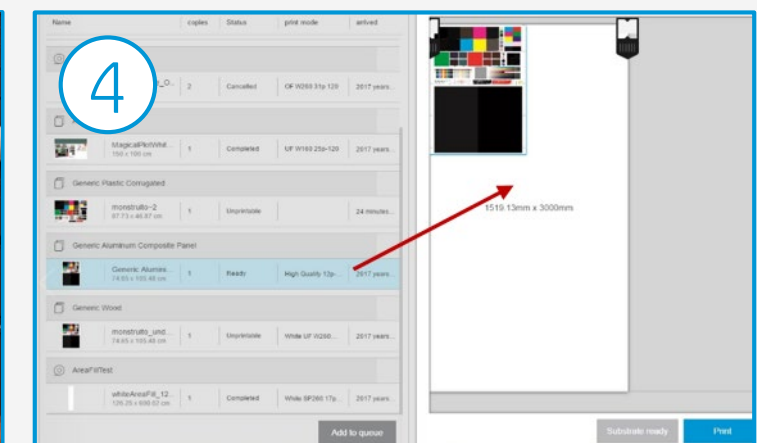
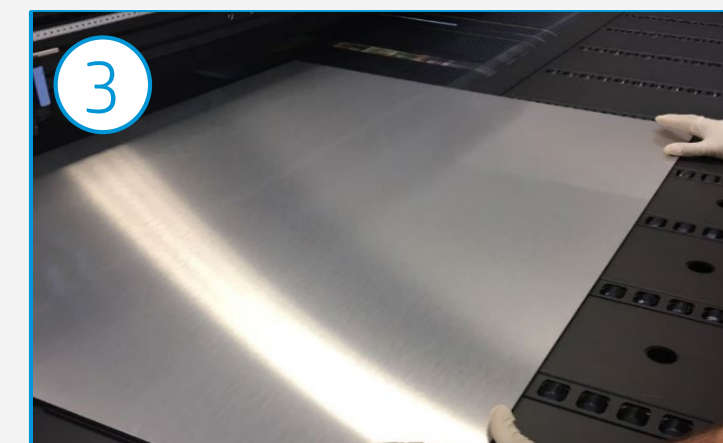
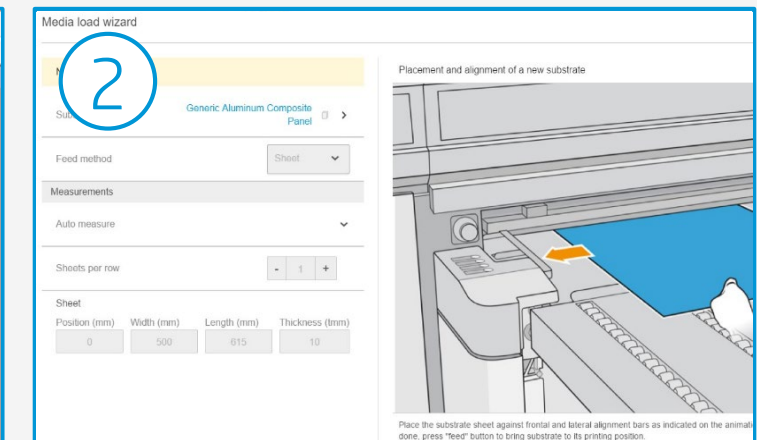
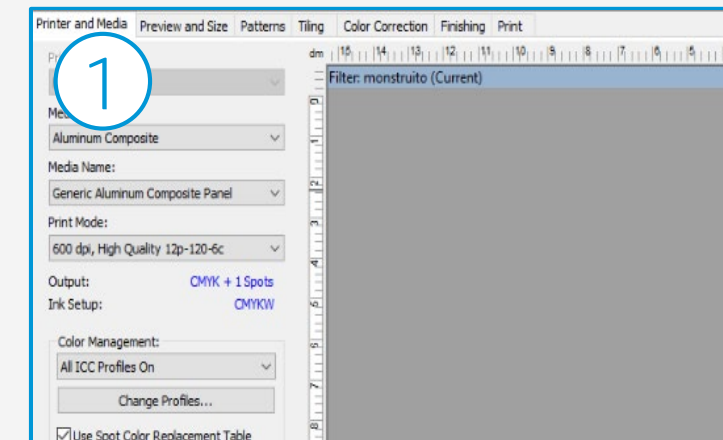

Press print

### NOTE:

Regarding print mode selection:

- Select “**High Quality**” mode to print images that do not require white.
- Select “**White UF260**” mode on substrates, including brushed or colored aluminum, when there is a need for realistic colors. In this mode, a white ink layer is printed first, and then a color layer is printed on top of it.
- Select “**White SP W260**” mode on substrates, including brushed or colored aluminum, for printing images where white is **not** mixed with other colors in the same area.

# How to print on aluminum composite panels



## Post-print finishing

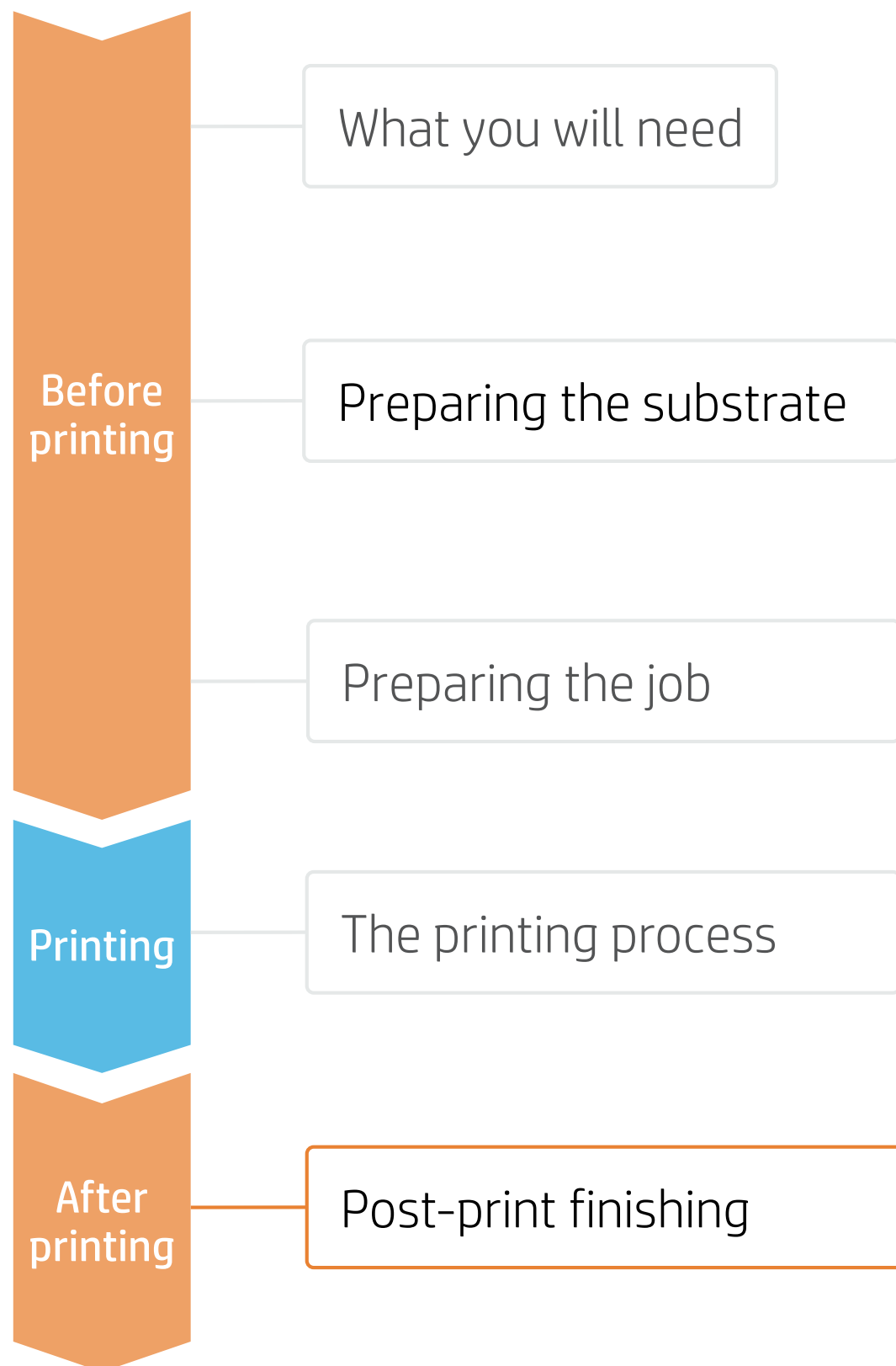

### 1. Handling samples

HP recommends using gloves when handling samples immediately after printing, as the panel will be hot. Use caution when loading or lifting sheets from the tables, as the substrate and ink can be scratched.

**NOTE:** Ink adhesion may improve over 24 hours. However, it is possible to handle, machine, and finish samples immediately after printing.



### 2. Sample protection with Film (optional)

It is recommended for protecting samples that will be exposed to the outdoors, samples that will be placed in high traffic zones or exposed to scratches or wear, and also on samples that will be in contact with cleaning products.

The easiest way to protect samples is to apply a film laminate once the sample has cooled down.

The protection process can also be done in later stages.

#### NOTES:

- HP recommends using cold, pressure-activated laminates to protect aluminum boards. Latex inks are compatible with most laminate films containing water and solvent-based adhesives. Laminates that have been tested by HP with good results are: Avery DOL2000, Avery DOL3000, and 3M 8038G.
- HP does not recommend using heat-activated laminates to protect aluminum boards as there is a high risk of ink delamination.
- We highly recommend letting the aluminum boards cool down prior to laminating. If samples are laminated while hot there is some risk of ink delamination.

#### TIPS:

- When laminating samples we recommend decreasing the overcoat amount to 0.5dpp. By reducing the Overcoat usage, we maximize ink and laminate adhesion and optimize printing cost.
- Most aluminum boards contain a surface lacquer that helps achieve good ink adhesion. Ink adhesion greatly depends on the lacquer chemistry and its ink interaction. We recommend performing a compatibility test (tape adhesion test on unprotected samples) prior to laminating the boards. Boards showing poor ink adhesion may delaminate easily.

## Post-print finishing

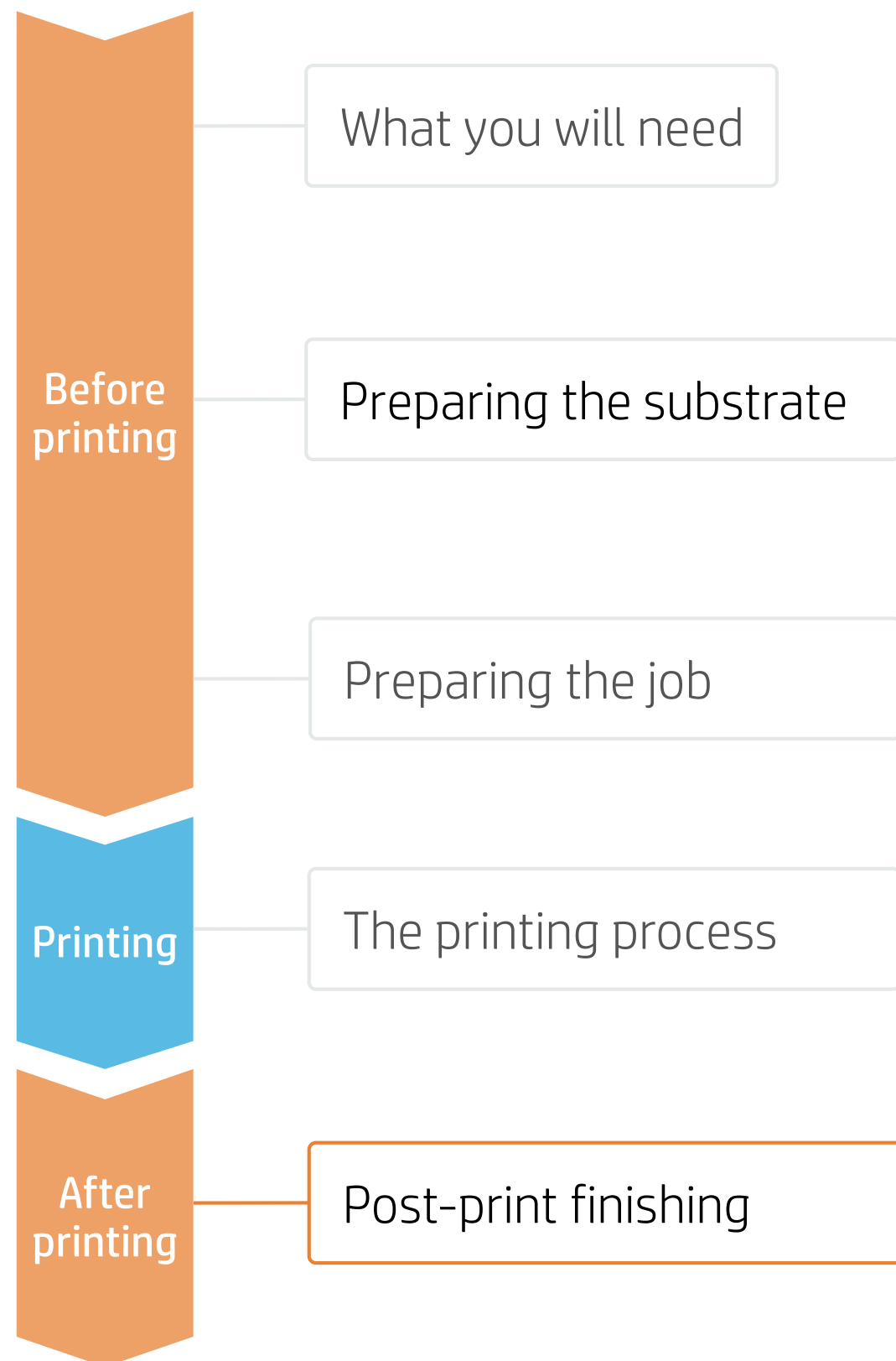

### 3. Sample protection with Liquid Laminates for Indoor (optional)

It is recommended to protect samples that will be placed in high traffic zones or exposed to scratches or wear, and also on samples that will be in contact with cleaning products.

Find information about Liquid laminates manually applied and tested by HP: Marabu Clear Jet A2000 and A&I coatings Writeboard paint.

The protection process can also be done in later stages.

Coating Vendor	Liquid Laminates	Application Method	Range
Marabu	Clear Jet A2000 (solvent based 1 component)	Brush, Roll, Spray can aerosol, Spray gun (HVLP)	Gloss & semi-gloss versions
A&I Coatings	Writeboard Paint (water based 2 components)	Spray gun (HVLP) nozzle 1.2-1.8	Gloss version

#### 💡 TIPS:

- When applying a varnish on printed samples we recommend decreasing the overcoat amount to 0 dpp. By reducing the Overcoat usage we maximize Varnish adhesion and we optimize printing cost.
- Most aluminum boards contain a surface lacquer that helps achieving good ink adhesion, laminant, or varnish adhesion. Ink and varnish adhesion greatly depends on the lacquer chemistry and its interactions. We recommend performing a compatibility test (tape adhesion test) with ink and varnish prior to applying the varnish to the job. Boards showing poor ink adhesion may delaminate easily.

⚠️ **HEALTH & SAFETY:** Read MSDS before handling the Coatings.

## Post-print finishing

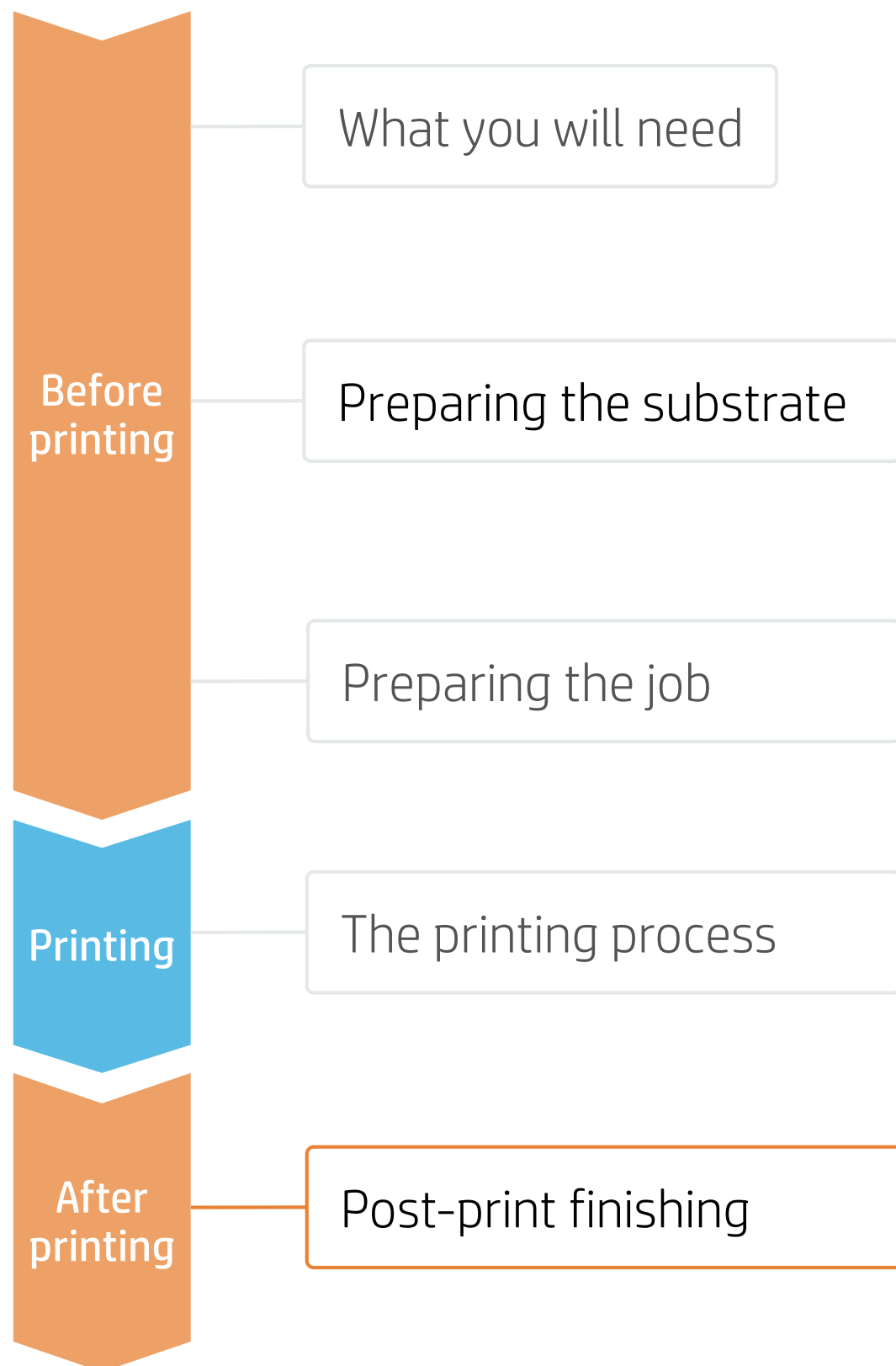

### 3a. Liquid Laminant Application Spray Can Marabu Clear Jet A2000 (optional)



#### 1. Coat application

Shake the can well and apply the spray from edge to edge at a 45° angle. Apply the second pass perpendicular to the previous direction.

Marabu Video [https://youtu.be/IWPbA\\_20AEo](https://youtu.be/IWPbA_20AEo)

#### 2. Dry time 48h

Dry panels at room temperature (T>20°C and HR<50%) in a clean and ventilated area for 48h before stacking.

#### 3. Fully cured after 3 days

The product will be fully cured and achieve final coating properties 3 days after application.

#### NOTES:

- When using Marabu products, we applied 3 passes, waited 30 min, and applied 3 more passes. Other coatings can require different quantities or different timing for Drying and Curing.
- Do not put protective film or paper between laminated samples to prevent from bonding during transportation.
- Tests were performed with Clear Jet Aerosol A2000 on ACP 3A Dilite White. Other Aluminum composite brands must be tested. In the case of big jobs, spray gun application is recommended.
- More information can be found at the Marabu web site or by contacting your local Marabu representative: [www.marabu-northamerica.com/products/product-overview/liquid-coatings.html](http://www.marabu-northamerica.com/products/product-overview/liquid-coatings.html)

**HEALTH & SAFETY:** Protective gloves and protective goggles are recommended (complete information in MSDS).



# How to print on aluminum composite panels



## Post-print finishing

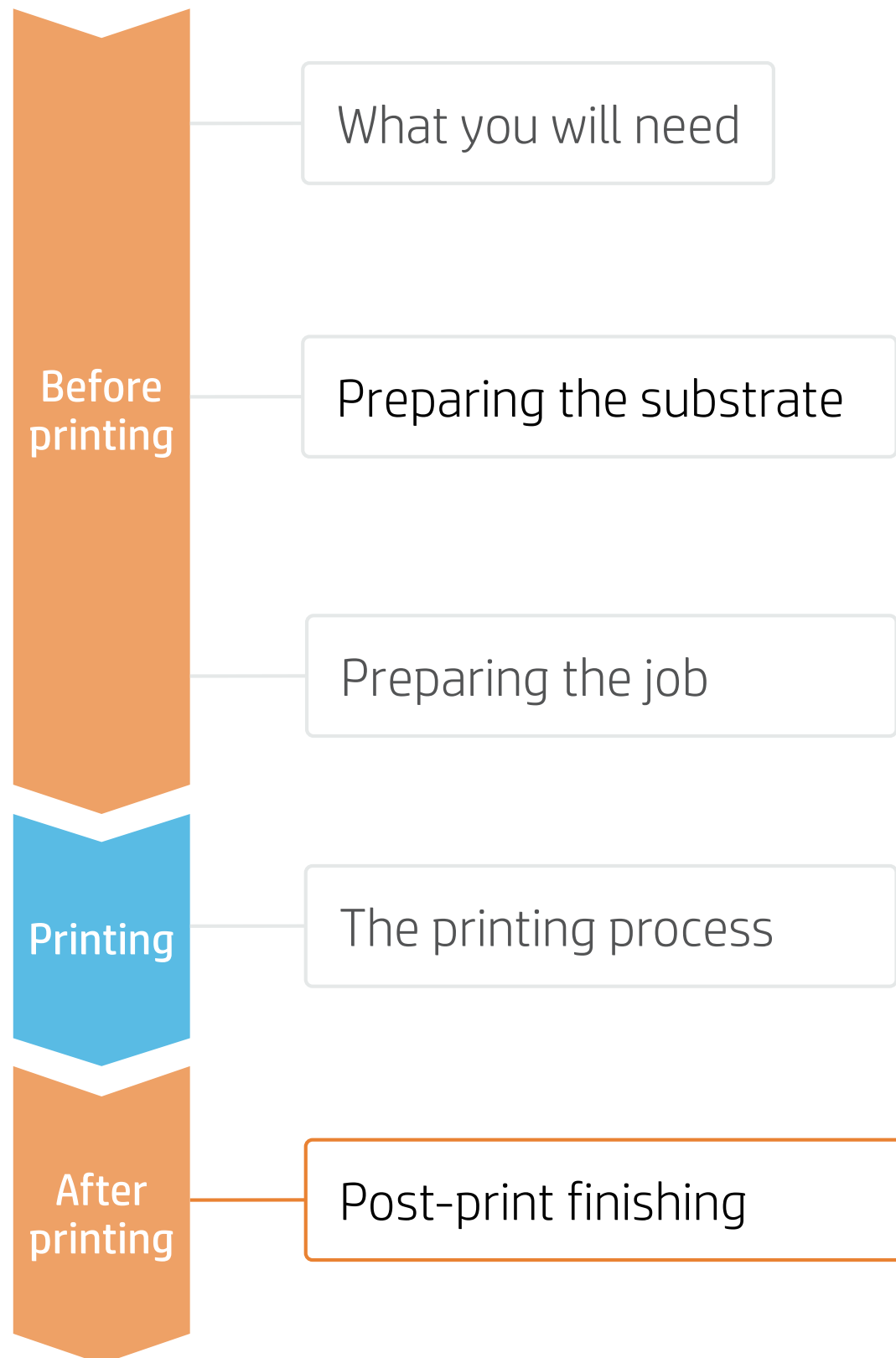

### 3b. 2 components Spray gun Application A&I Writeboard Paint (optional)



#### 1. Mix and Stir products

Stir Pack A with pack B for a minimum of 3 minutes in a ratio of 2:1 (pack A: pack B) by volume. Add some water and stir again. Pot life: 1-2 hours



#### 2. Filter the paint

Pour the paint through a filter to fill the spray gun.



#### 3. Application settings

Check and adjust the HVLP spray gun prior to performing paint application on the job.

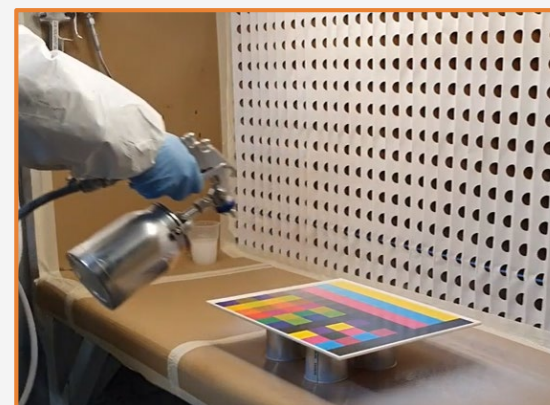

#### 4. Coat application

Place the panel horizontally and apply two coats.



#### 5. Clean Spray Gun

Clean the Spray gun and tools immediately after application with clean water. Or clean the tools if down time is going to exceed the pot life (1-2h).



#### 6. Dry time 3 days

Dry panels at room temperature ( $T > 20^{\circ}\text{C}$  and  $\text{HR} < 50\%$ ) in a clean and ventilated area for 3 days before stacking.



#### 7. Fully cured 7 days

The product will be fully cured and achieve final coating properties 7 days after coat application.

#### NOTES:

- Tests performed with Writeboard Paint and ACP 3A Dilite White and 3A Dibond. Other Aluminum composite brands must be tested. In case of long jobs a paint cabin is recommended.
- More information can be found at the A&I Coatings web site or contact your local A&I Coatings representative: [www.aicoatings.com.au](http://www.aicoatings.com.au)

**HEALTH & SAFETY:** Protective gloves and protective goggles are recommended (complete information in MSDS).

## Post-print finishing

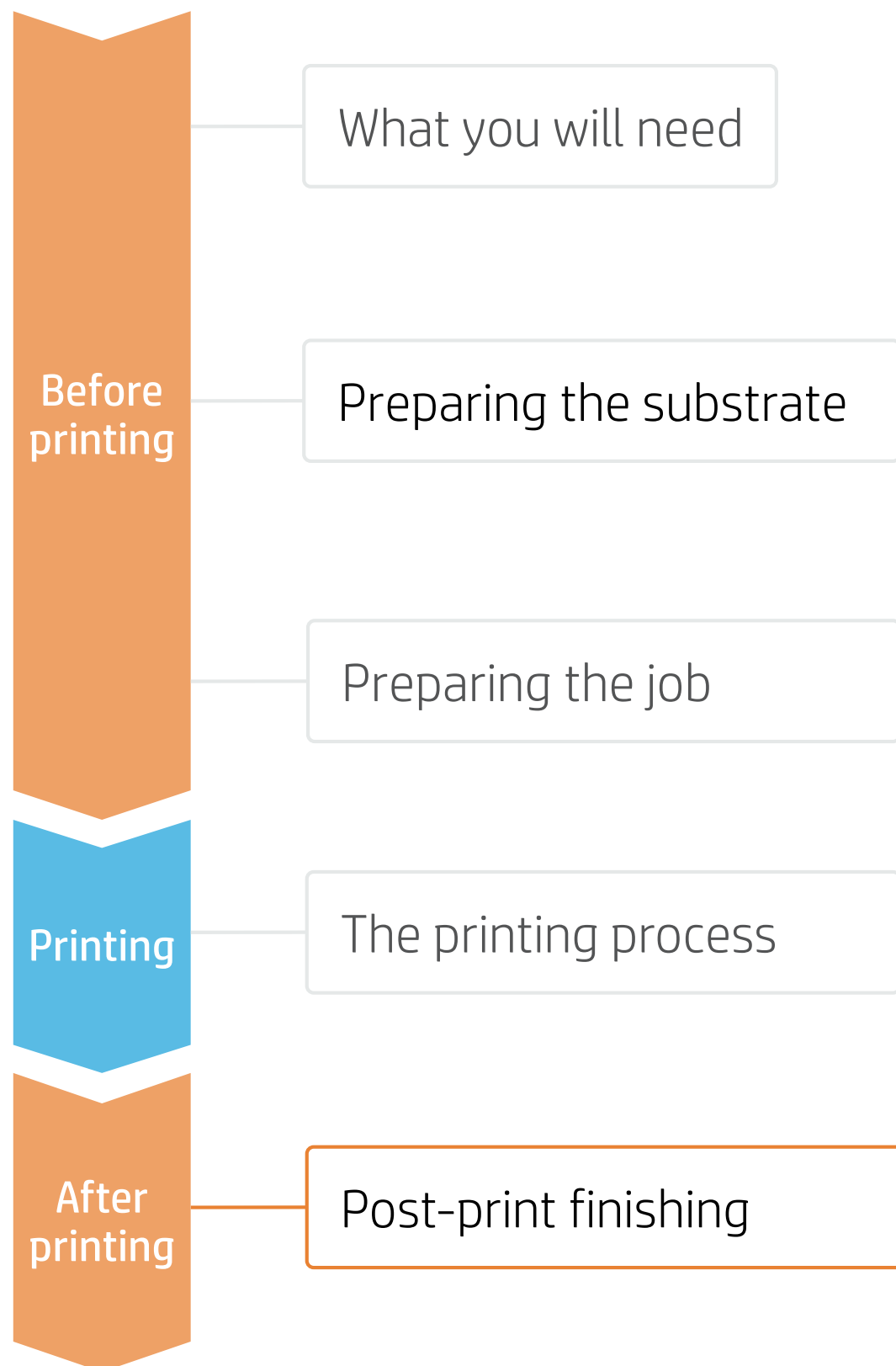

### 4. Cutting

Cut samples to their final dimensions if you have not done so previously.

**NOTE:** It is possible to successfully cut different panels on a Zünd XL3200 table cutter using the following settings:  
**Head** - Router module RM-A QC; **Drill** - R204 (4 mm); **Cutting Speed** – 120 mm/s.

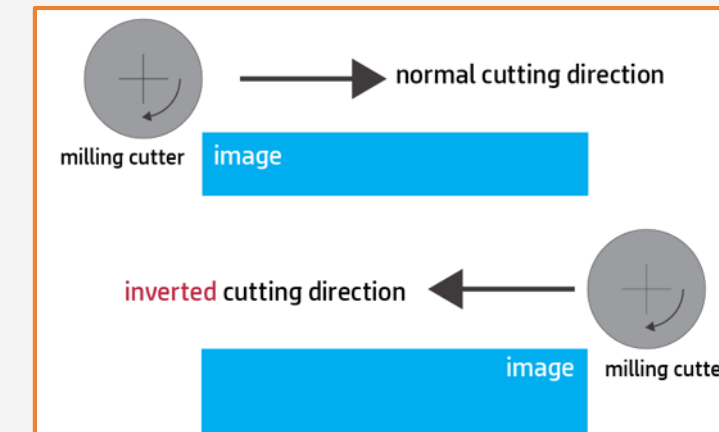

**NOTE:** When routing aluminum panels, one edge always offers a cleaner cut (the upper edge-side).

**TIP:** In case of obtaining a rough edge finish, or if the ink shows chipping, we recommend inverting the router cutting direction.

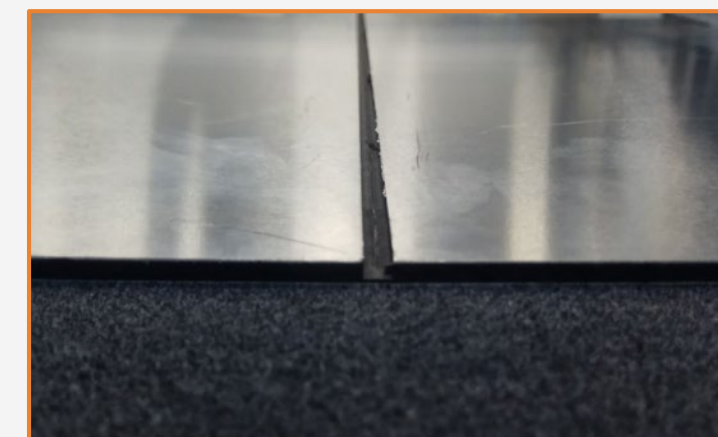

### 5. Cutting (V-Cut, channel cut)

If the panel needs to be bent, cut a channel or perform a v-cut on the back side (unprinted side) of the aluminum panel.

## Post-print finishing

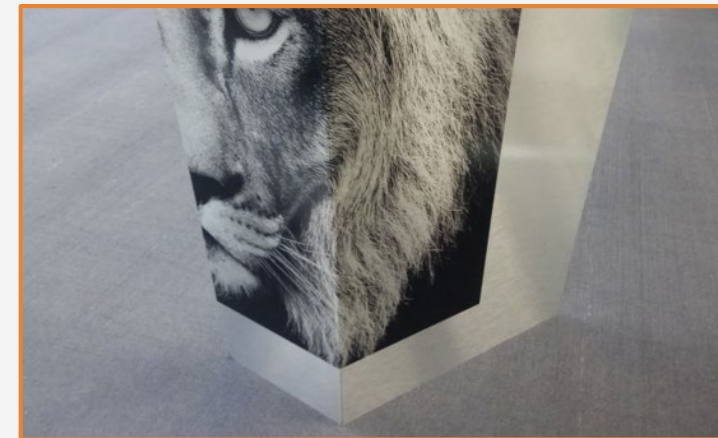
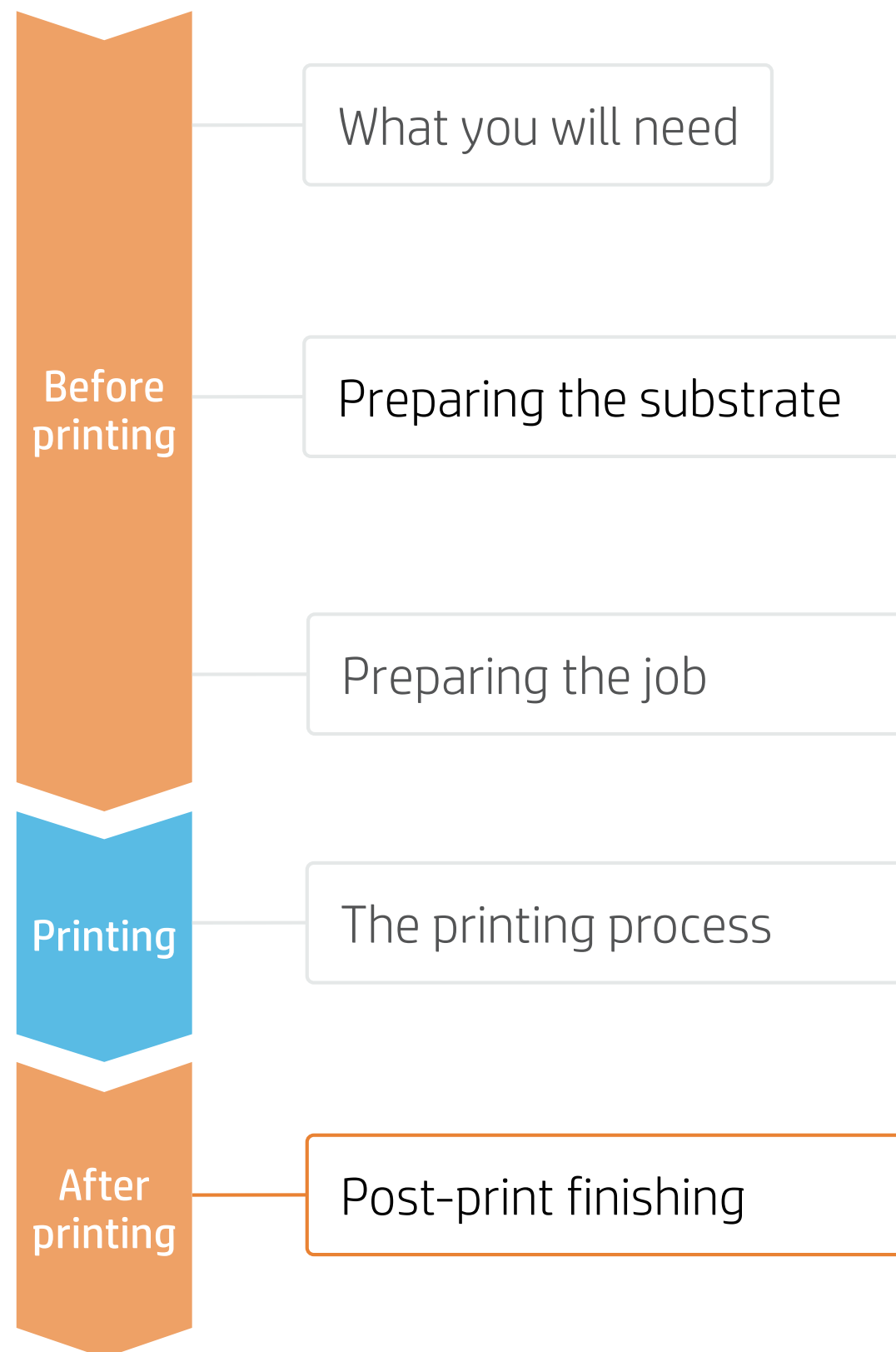

### 6. Bending

It is possible to bend panels printed with latex inks, if the panel itself allows. Latex inks are flexible and will not crack when printed on most aluminum panels.

**NOTE:** Ink or substrate may crack if the sample is bent several times.

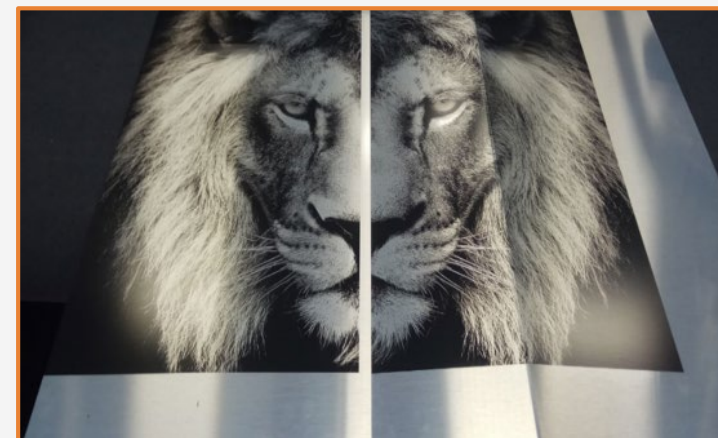

### 7. Joining Two Boards

It is possible to use rivets to join different aluminum composite panels. Follow these steps:

- 5a. Drilling
- 5b. Riveting

# How to print on aluminum composite panels



## Post-print finishing

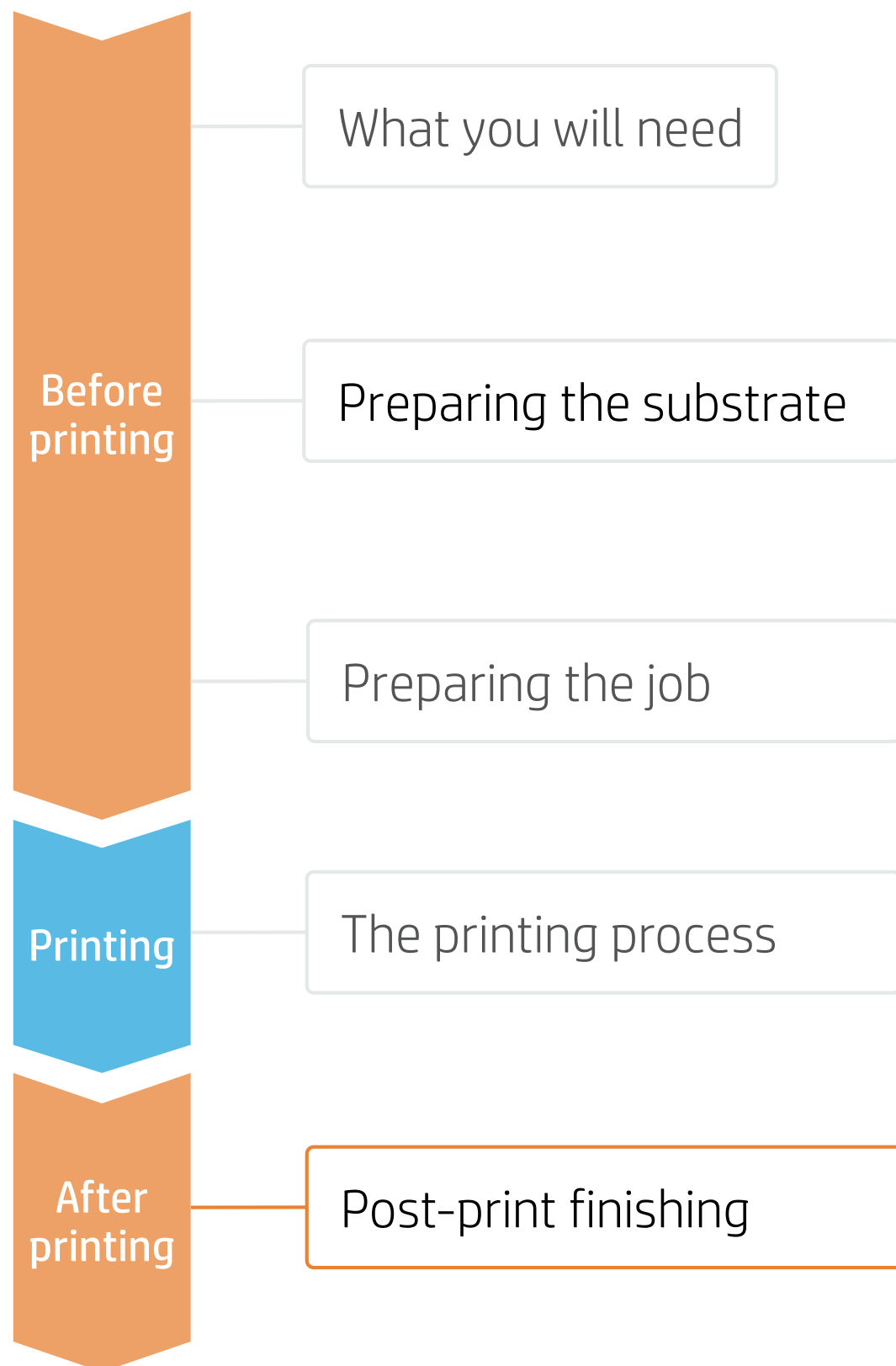

### 7a. Drilling

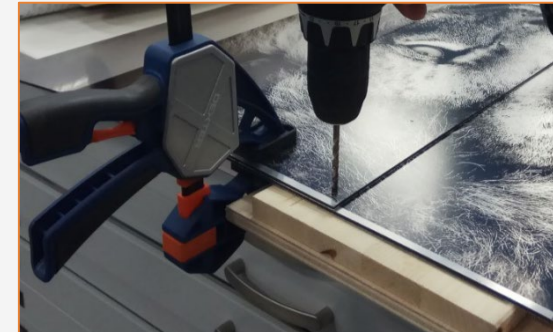

When cutting panels, leave a 30 mm (1.2") unprinted margin on one of the panels. This unprinted margin will be used to join both panels.

Overlap the panels and align the images on both. Secure the panels with a joiner clamp and drill through both panels using a metal drill. Leave at least 15 mm (0.6") between the hole and the panel edge.

**NOTE:** It is recommended to place a piece of wood under the bottom panel for an aesthetically better finish of the hole.

### 7b. Riveting

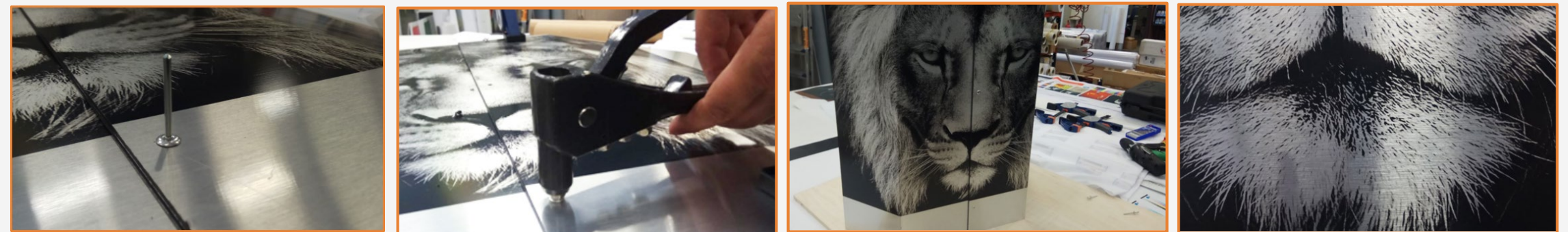

Use a rivet that matches the diameter of the hole. HP recommends using a rivet with a minimum length of 12 mm (0.5") to join two 3 mm (0.12") panels. Use a rivet tool to join the two panel pieces.

**NOTE:** Due to flexibility of latex ink and its ability to be cut without chipping, the printed surface can be bent without cracking and panel joints can be nearly invisible.

# How to print on aluminum composite panels



Partnership

Learn more at:

[hpllatexknowledgecenter.com](https://hpllatexknowledgecenter.com)



