

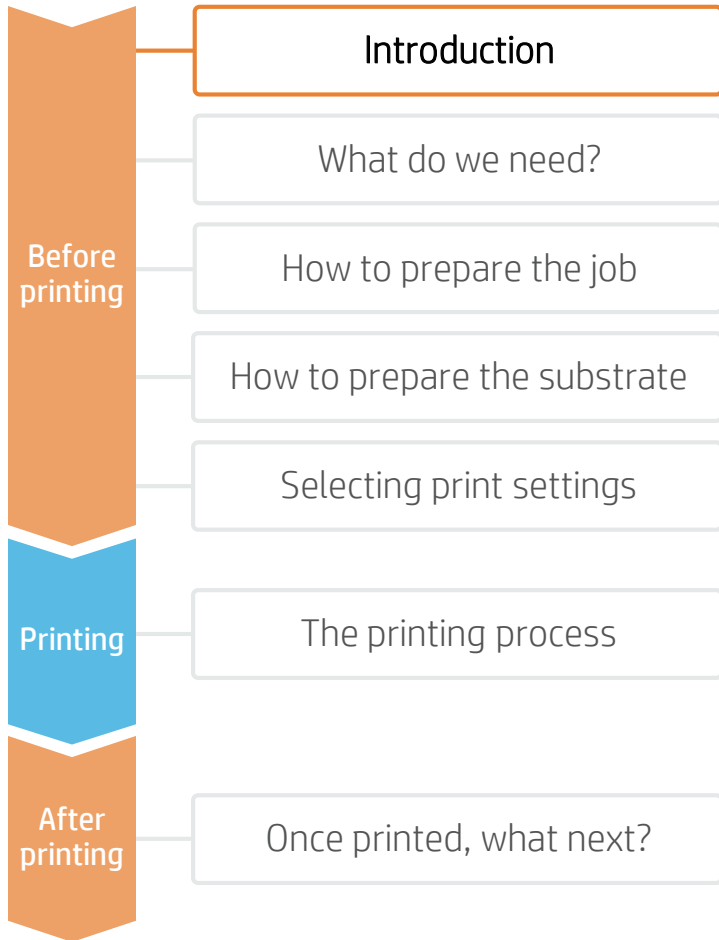

Vacuum Thermoforming indoor applications with the Latex R Series

This document will explain how to perform indoor thermoforming applications with HIPS on Latex R Series printers.

Introduction



There is increasing demand for customized and digitally printed applications.

Latex inks bring considerable advantages to printed thermoforming applications: due to its flexibility and temperature resistance, it can provide thermoformed prints with rich, deep colors that don't fade when stretched into deep-draw forms.



Thermoforming is manufacturing process where a plastic sheet is heated to a pliable forming temperature, formed to a specific shape in a mold to create a usable product.

The sheet is heated in an oven to a temperature that permits it to be stretched into or onto a mold, and then is cooled into the finished shape.

The simplified version of this process is called vacuum forming.

A wide range of substrate can be used in thermoforming, and the end product can range from prototypes, point of sale material, and blister packs to industrial parts.

Vacuum Thermoforming on latex inks

Introduction

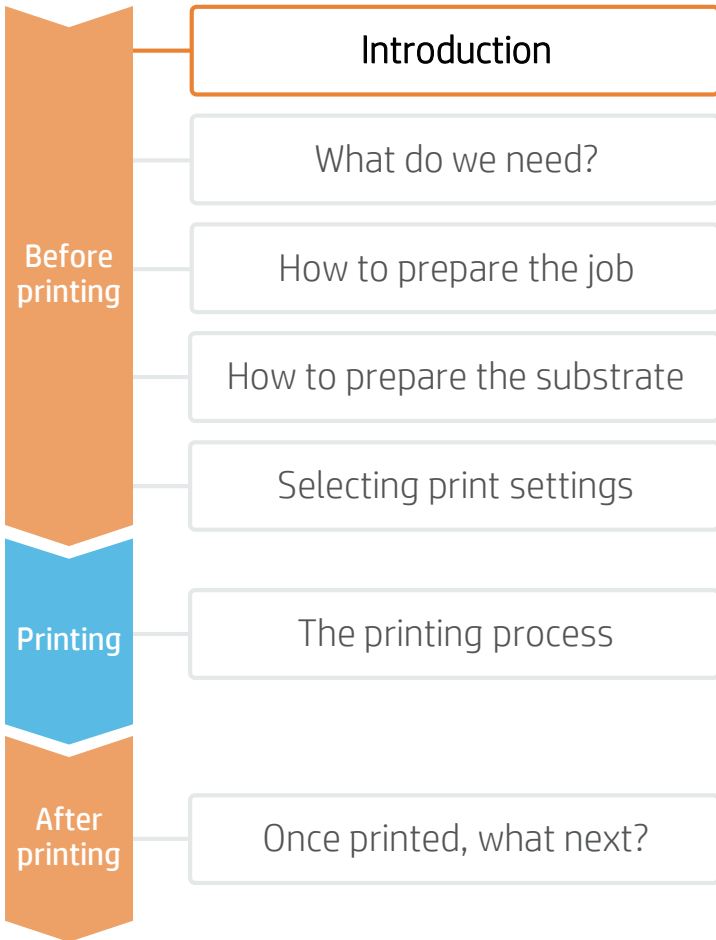

The whole thermoforming process is a relatively long process that consists of different steps, most of them not related to printing. From designing and preparing the mold up to trimming the sign, the basic thermoforming process would be similar to the following:

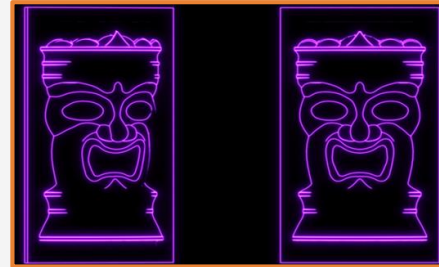

1. Create a CAD Model with the shape required.



2. Create a mold with the forming shape.



3. Develop the artwork using standard design tools.



4. Some shapes require an image pre-deformation process to match the mold and artwork*.

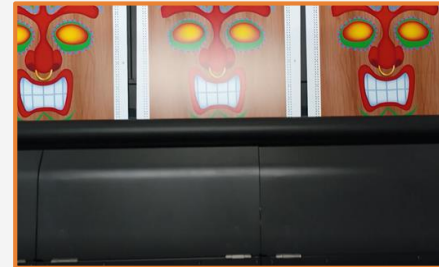

5. Print the final (pre-deformed) image.



6. Protect the samples with an elastic clear coat (optional). This process can also be done after thermoforming.



7. Thermoform the printed sample**.



8. Trim the image and discard all excess material from the part*.



9. The part is ready!

*Distortion Arts pre-deformation workflow shown

**See process on next page

Vacuum Thermoforming on latex inks

Introduction

Before printing	Introduction
	What do we need?
	How to prepare the job
	How to prepare the substrate
	Selecting print settings
Printing	The printing process
After printing	Once printed, what next?



The basic thermoforming process (steps 7 and 8 on previous page) consist of a number of substeps. The process explained below only considers the thermoforming basics.

Depending on piece shape and requirements, additional techniques such as plug assist or pre-stretching methods may be required. Also depending on the substrates and thickness being used, a pre-warm (annealing) or a dual-side heater may be needed.

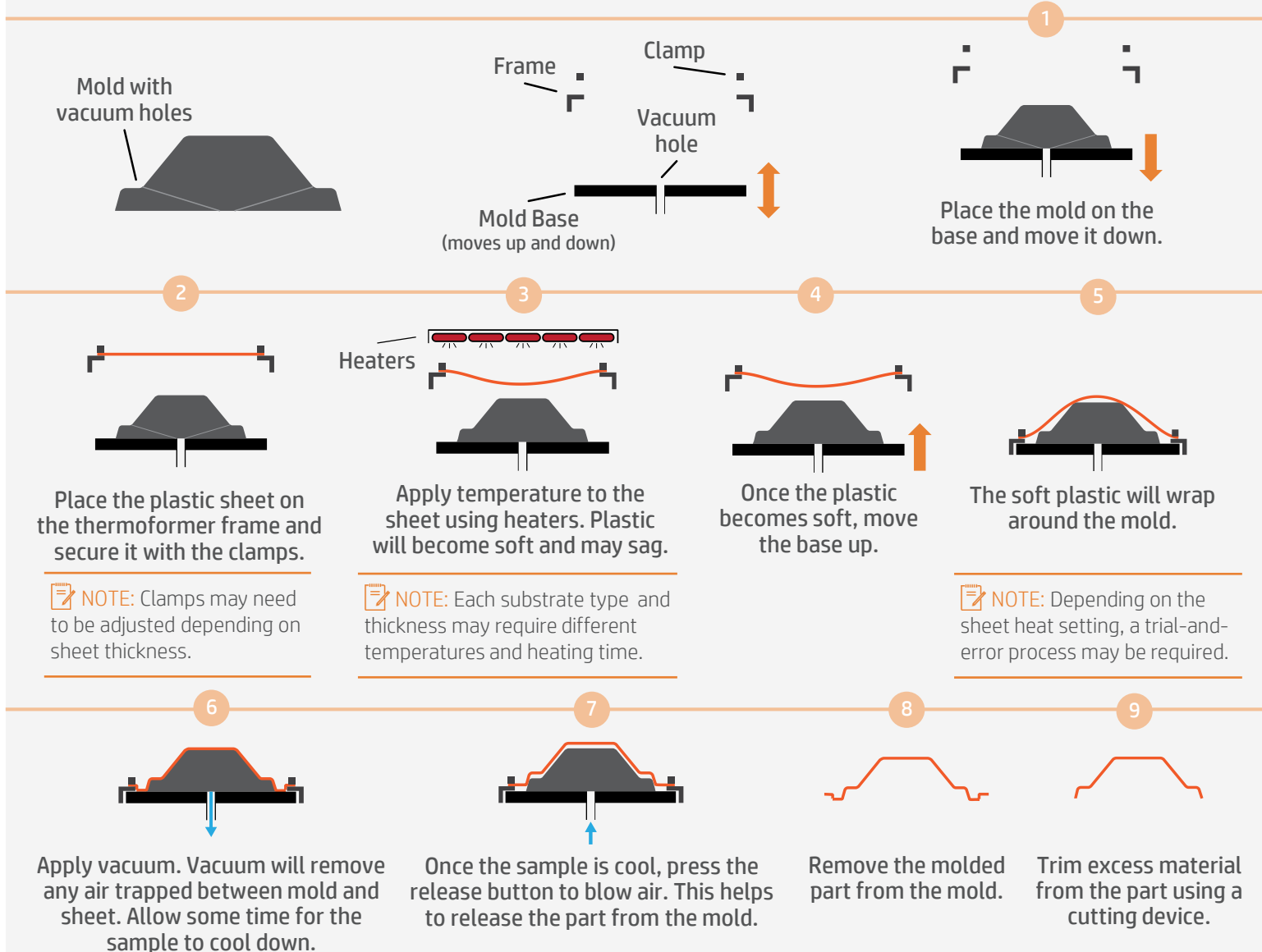

What do we need?

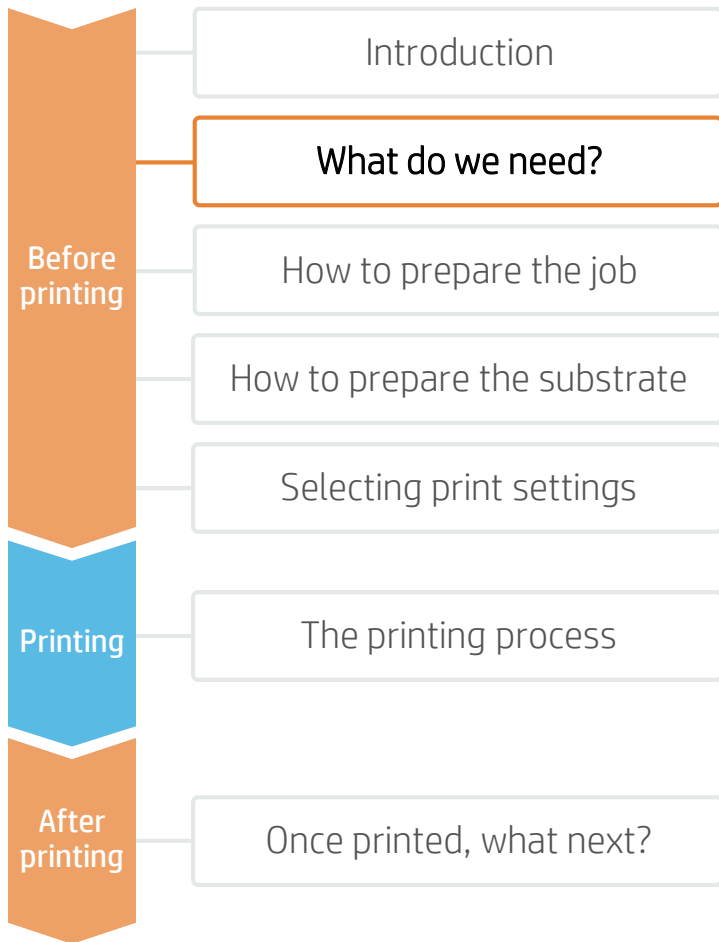

HIPS boards

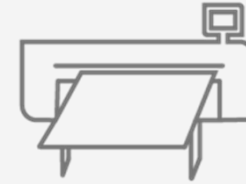

HP Latex R Series Printer



Cutting device



Software tools (RIP, image editor, etc.)



Gloves



Mold

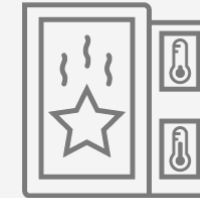

Thermoforming machine



Deformation Software/Service (Quadraxis, Distortion arts)

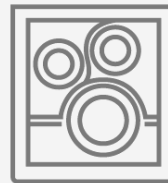

Coater (optional)



Clear Coat (Varnish) (optional)

Vacuum Thermoforming on latex inks

How to prepare the job

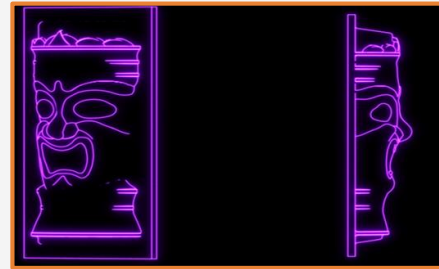
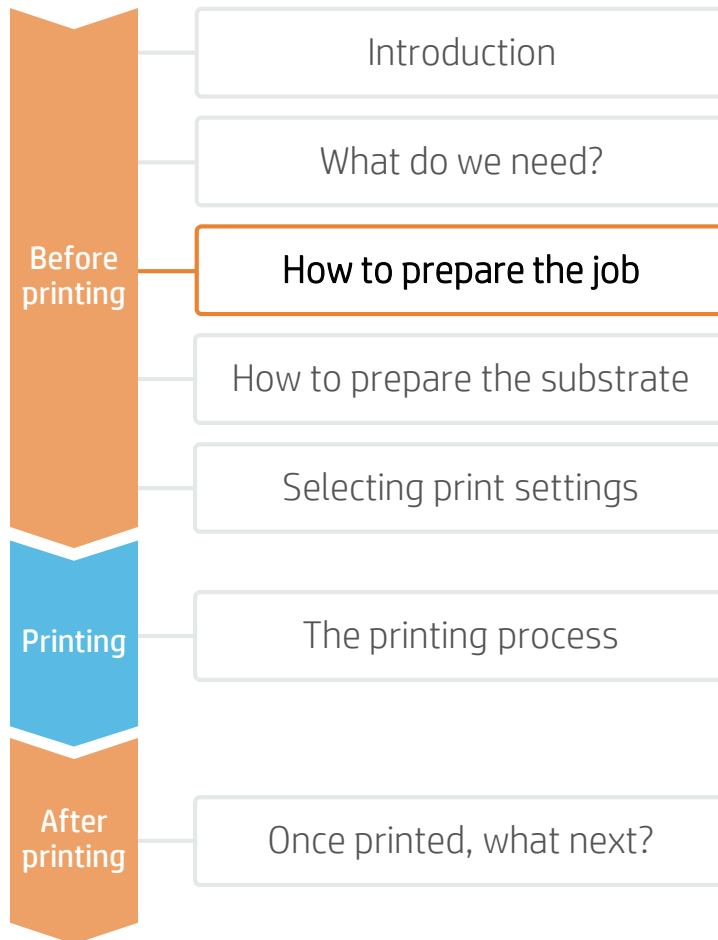

1. CAD design

Before starting a job, we need to design the piece that we want to create. Use 3D software to help you create the model.



2. Mold creation and considerations

With the design we can create a mold. Creating a proper mold is key for the success of the entire process. There are companies specialized in creating molds that will be able to help you.

Vacuum thermoforming molds are relatively inexpensive compared to other forming techniques, such as plastic injection. Key points regarding molds:

2.1 Draw (Stretch) value

Draw value is one of the most important values to consider when creating a mold for thermoforming. Draw value is defined as the amount of area we have to cover during molding, divided by the amount of material we have available to use.

EXAMPLE: A 10cm cube needs to be created from a 10x10cm piece of plastic.

- Area of the cube to be covered: 5 sides of 10x10cm = 500cm²
- Available area: 10x10cm = 100cm²
- Draw ratio: 500/100 = 5

Draw value is also important because it will determine the thickness of the required substrate, as when a substrate is stretched it becomes thinner.

Draw ratios up to 3-to-1 are common in thermoforming.

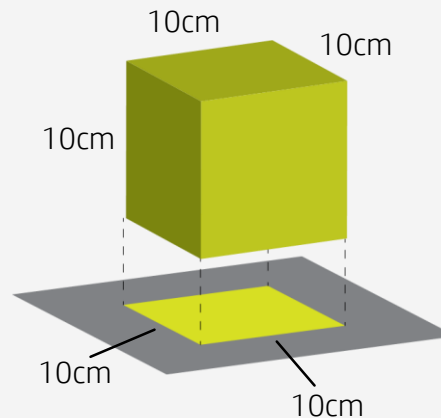

How to prepare the job

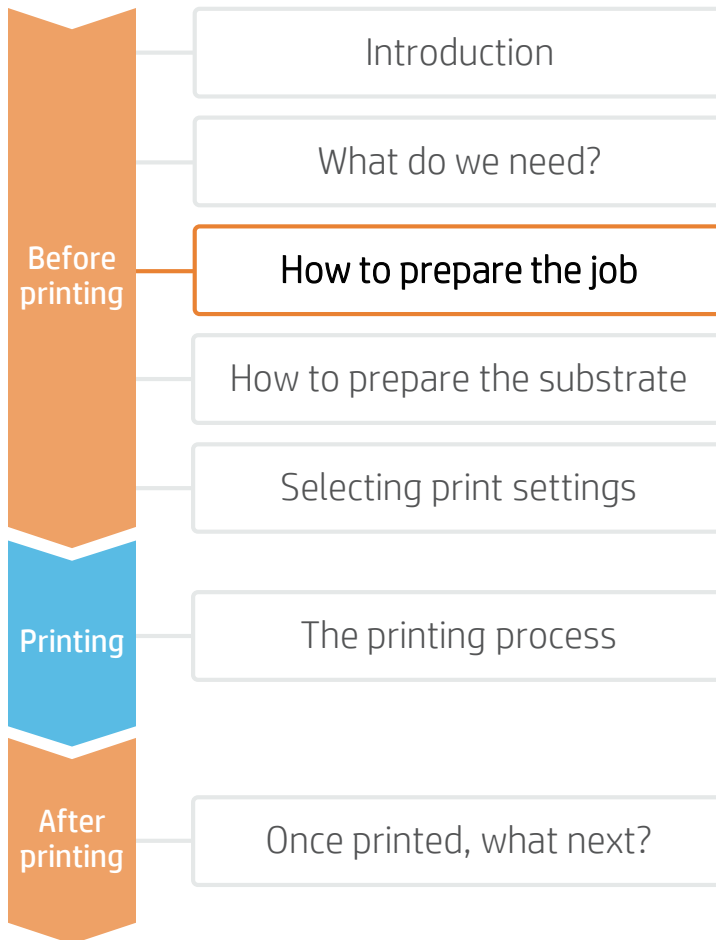

2.2 Mold materials

A wide range of materials can be used to create molds: plaster, mdf (wood), aluminum, and resin. The mold material selection will greatly depend on the number of samples to form before mold degradation, and the cost of it. Plaster or MDF molds can be best used to form few part numbers on low demanding temperature substrates such as HIPS. For longer runs, an aluminum or resin mold will be the best option.



Plaster Molds

- Cheap and fast. Allow 3 days for mold drying
- Suitable for short forming cycles (around 50)
- Do not require vacuum holes as plaster is porous

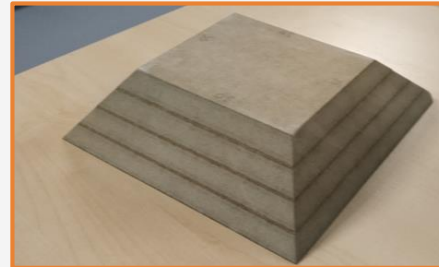

MDF Molds

- Cheap and fast.
- Suitable for more forming cycles than plaster (>100)
- Does not require vacuum holes as MDF is porous
- MDF will suffer from expansion and contraction during forming



Resin Molds

- Durable molds with good forming finish
- Suitable for high numbers of forming cycles
- Requires vacuum holes



Aluminum Molds

- The most expensive option
- Almost unlimited life
- Good strength and thermal properties that allow quick heat dissipation
- Requires vacuum holes

How to prepare the job

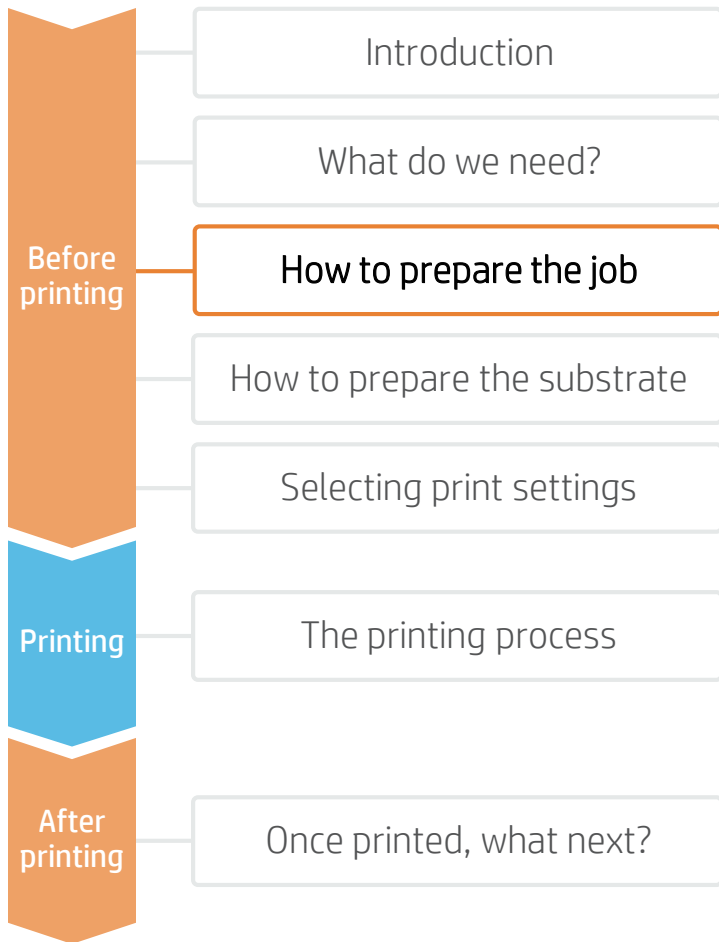

2.3 Male (positive) and female (negative) molds

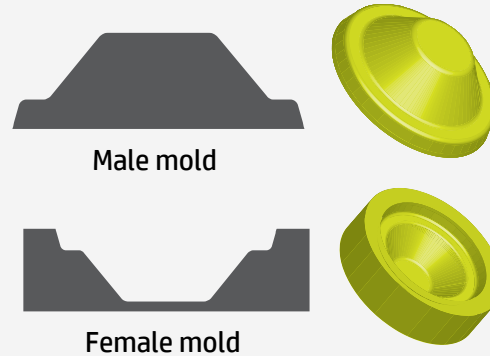

There are basically 2 types of mold geometry: **male** (positive) and **female** (negative). Several factors affect the decision to use one or the other:

Surface finish: the sheet surface not touching the mold will have better finish since it will not pick up marks or dust from the mold.

Dimension tolerance: the surface touching the mold will have the highest definition and best dimensional tolerances, especially with thicker plastics.

Printing side: although latex inks have been successfully tested in different mold substrates and geometries, forming with the printed surface against the mold has more risk of damaging the ink.

We recommend discussing mold requirements with your mold manufacturer.

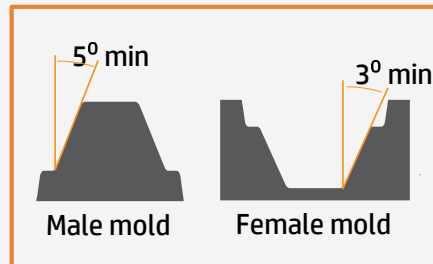

2.4 Mold Draft angles

Molds need to have angled faces to facilitate part ejection. The draft angle greatly depends on various factors: quality of the mold being used, substrate being used, forming depth... In general, female molds require lower draft angles as when cooled the piece will tend to contract and release from the mold itself. Male molds will require a greater angle. We recommend a minimum of 5 degrees for male molds and 3 degrees for female ones.

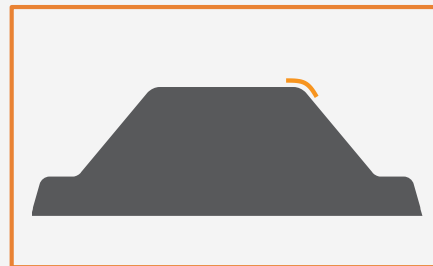

2.5 Mold radius

It is possible but not desirable to form right-angled corners, as these will be the first fracture points of the part.

Generally, the radius of a piece greatly depends on its size and draw ratio. If a part has more than 2:1 draw ratio we recommend a 12.5mm (1/2") radius. If a part has a 3:1 draw ratio it's desirable to have a 25mm (1") minimum radius.

Vacuum Thermoforming on latex inks

How to prepare the job

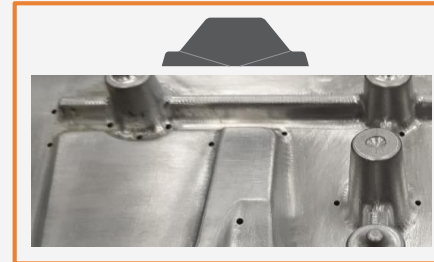
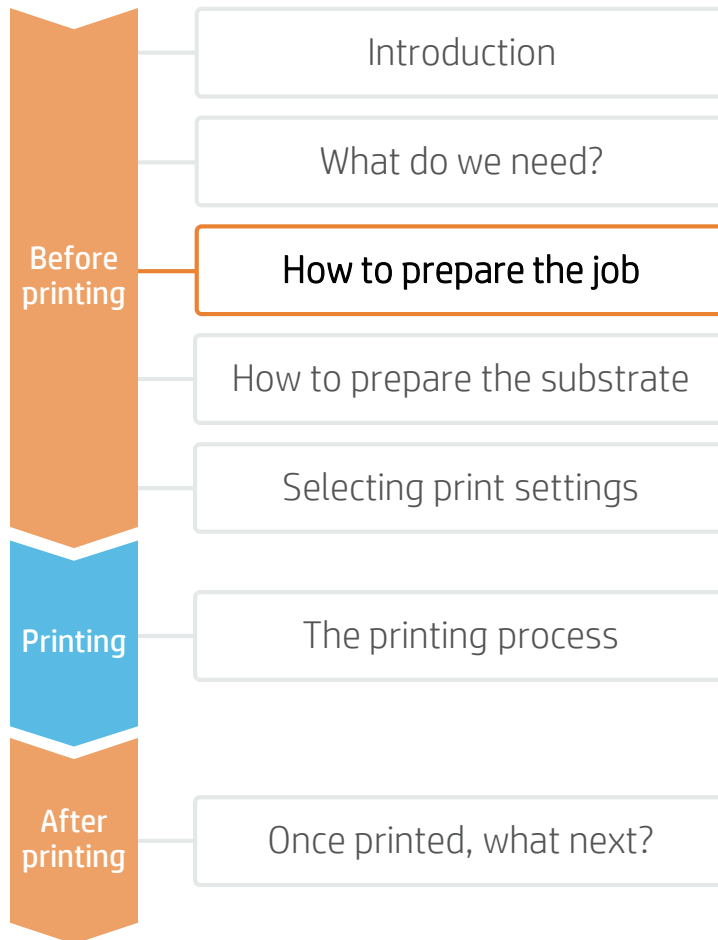

2.6 Vacuum (venting) holes

Vacuum holes are required for quick air release between sheet and mold when using non-porous molds. The number of vacuum holes should be kept to a minimum and the diameter should also be the minimum possible in order not to affect the finish of the surface of the final part.

If there are insufficient vacuum holes, the part will cool before reaching the desired final shape.

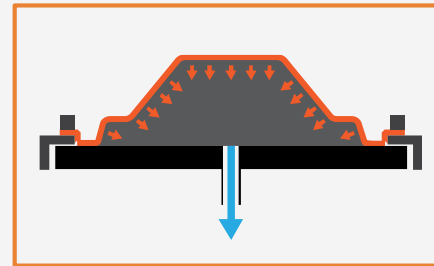

2.7 Shrinkage and mold release

During the cooling process, the formed sheet will tend to shrink onto a **male mold**.

Different plastics have different thermal shrinkage values and this will affect mold design. Difficulties in releasing the piece from the mold depend a lot on the mold design and its finish. If the mold has correct draft angles and the finish is adequate then piece ejection should be easy (some molds may need to be polished to avoid friction).

There are a number of oil and silicone release sprays which, when applied to the mold prior to forming, may facilitate piece ejection.

In some cases, placing talcum powder between the mold and sheet will also facilitate the demolding process.



3. Designing the artwork

Develop the artwork using any of the design tools available on the market (photoshop, illustrator...).

How to prepare the job

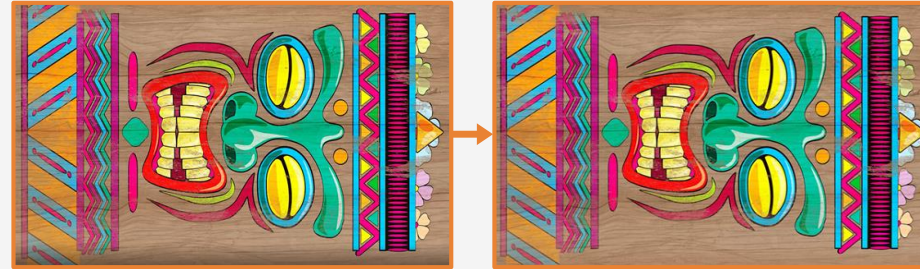
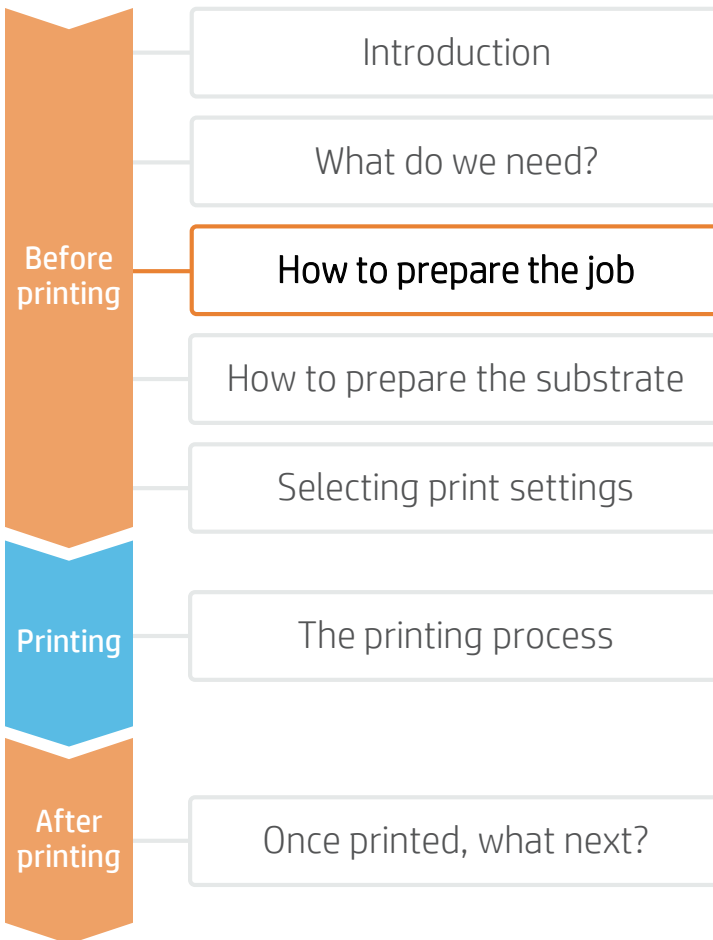

NOTE: It is important to have consistent forming parameters to create consistent deformations and shape matching.

4. Pre-deforming the image*

One of the most challenging processes in thermoforming is how to match 2D printed surfaces with the final 3D thermoformed (and therefore distorted) image.

For some easy shapes, the distortion can be directly done by a trial-and-error process in the design software.

*For more complicated shapes or designs, software can be the best or unique solution (Quadraxis.com) or Distortion Service (Distortionarts.com).

To pre-deform an image, follow these steps:

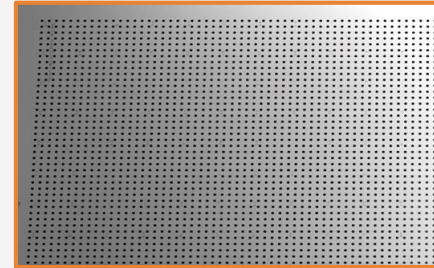

4.1 Print a grid

Once we have a mold, we need to print a grid file provided by Quadraxis Software or by Distortion Arts. Print the grid using the same substrate and settings you will use to print the final image.



4.2 Forming the grid

Thermoform the printed grid using the mold. The dots present on the grid will move.

NOTE: It is important to mold using the final forming parameters.

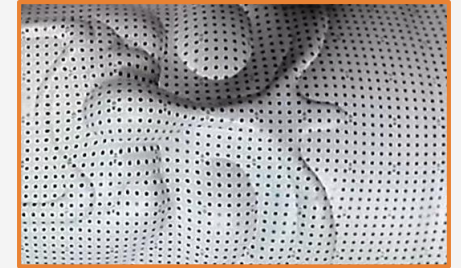

4.3 SW Pattern reading

Once formed we need to read the grid pattern using a provided camera (Quadraxis). The software will deform the image according to the deformed grid reading. In the case of Distortion Arts, we will need to send the formed grids to their headquarters.

We will receive a distorted image from them with which to print.

How to prepare the substrate

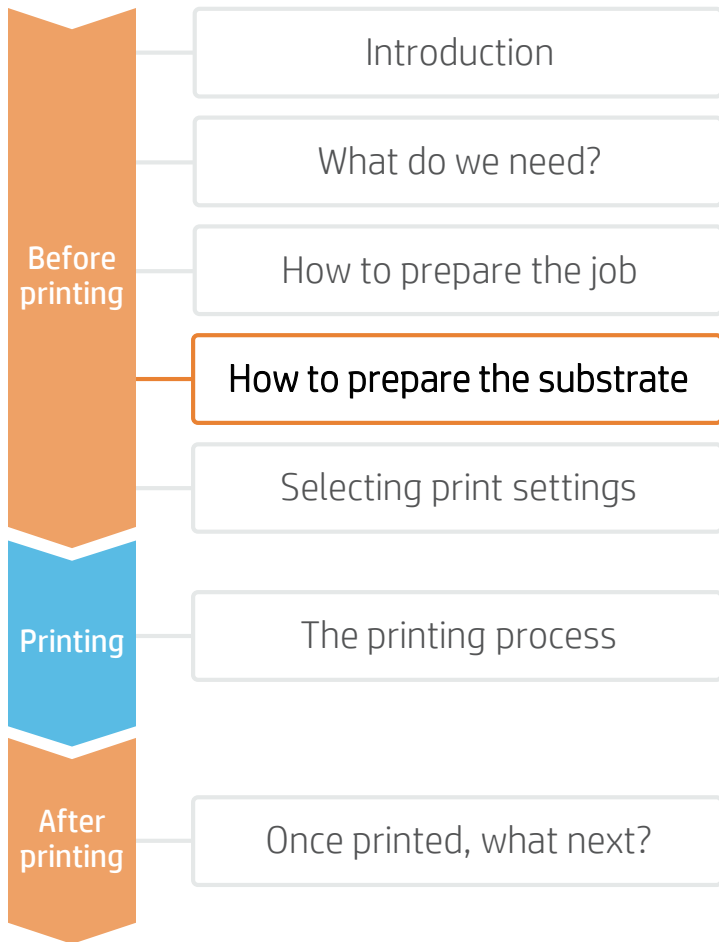

5. Substrate considerations (a bit of plastic theory)

Plastics comprise a wide range of substrates. Thermoplastics are the substrates that are used in the thermoforming process. That means that plastic softens when it is heated and hardens when cooled.

Thermoplastics can be classified into 2 main groups: Amorphous (PS, HIPS, ABS, Acrylic, PETG) or Crystalline (PE, PP..). Amorphous thermoplastics become soft and formable when they reach Glass Transition temperature (T_g). If heated further they reach a viscous state (T_v) but this change occurs over a range of temperatures and enables a wide forming range. Crystalline or semi-Crystalline substrates such as PE or PP have a more critical forming temperature. They rapidly move from T_g to T_v, having a narrow temperature forming range. Temperature control when forming crystalline materials is critical.

Overall, amorphous materials are easier to thermoform than crystalline, as their heating band is much wider. **In our indoor application we will focus on forming printed samples on HIPS.** HIPS is an easy to form amorphous thermoplastic requiring low forming temperatures. Due its poor UV resistance, HIPS is suitable for indoor applications only.



5.2. Substrate handling

Handle samples with care.

It is recommended to use gloves to prevent accidental cuts, and also to avoid leaving fingerprints on the surface. Marks and scratches created prior to printing will be visible after printing.



5.3 Cut

Cut the sample to the desired size using a device (table saw, cutting table...).

NOTE: Sample size will normally depend on the thermoforming machine's clamp size.



5.1 Ensure panel flatness

Ensure the board is flat prior to printing.

NOTE: If the panel is deformed there is a risk of printhead crashes. The use of edge holders may be necessary when printing on wavy substrates.



5.4 Cleaning

In case the substrate presents dust particles, remove them by wiping the surface with an anti-static cloth.

TIP: If an anti-static cloth is not available, use a 70% Isopropyl Alcohol / 30% water solution with a lint free cloth, and wipe the print surface. Let it dry before printing.

Selecting print settings

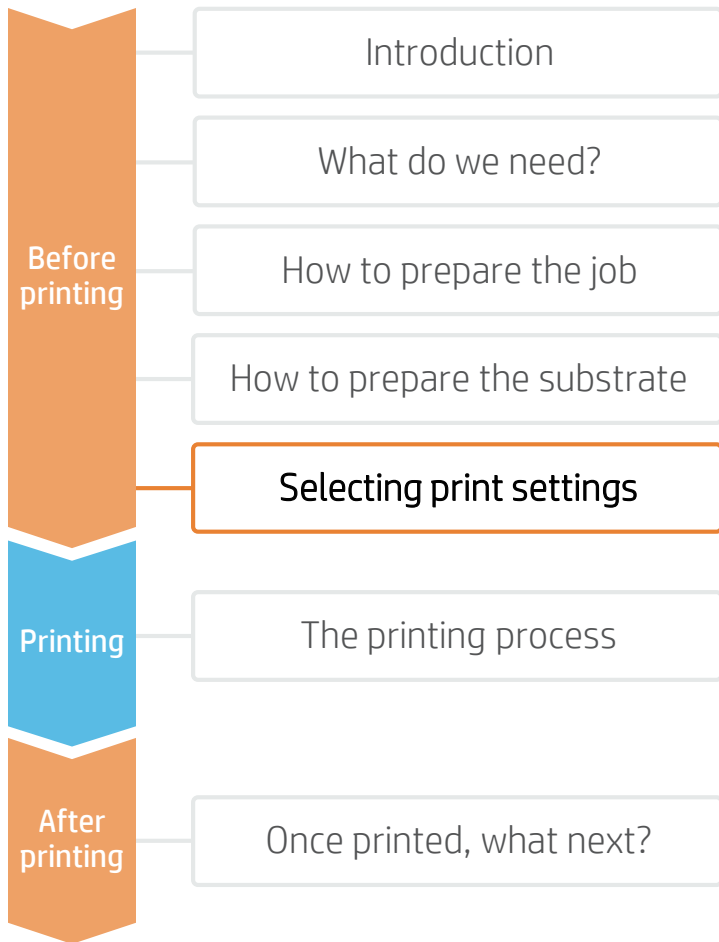

Now we're ready to print, but first we need to select the right print settings. Those settings are contained in the substrate presets and its printmodes.

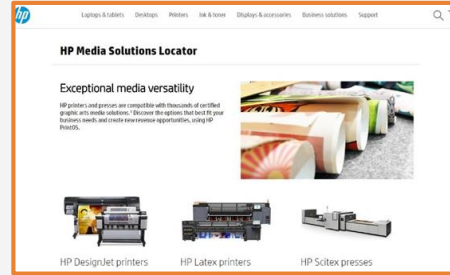

Plastic Solid substrate presets

Many HIPS substrates have been tested at hp. In some cases, a substrate preset has been created and is available for downloading from the HP Media Locator: <https://www.printos.com/ml/#/homeMediaLocator>

If the substrate you're using has an available substrate preset, we recommend downloading, installing, and using it on your printer and RIP. If there is no substrate preset for the specific substrate being used, using the "Generic Plastic Solid" or "Generic Backlit Plastic Solid" substrate preset may be a good starting point option.

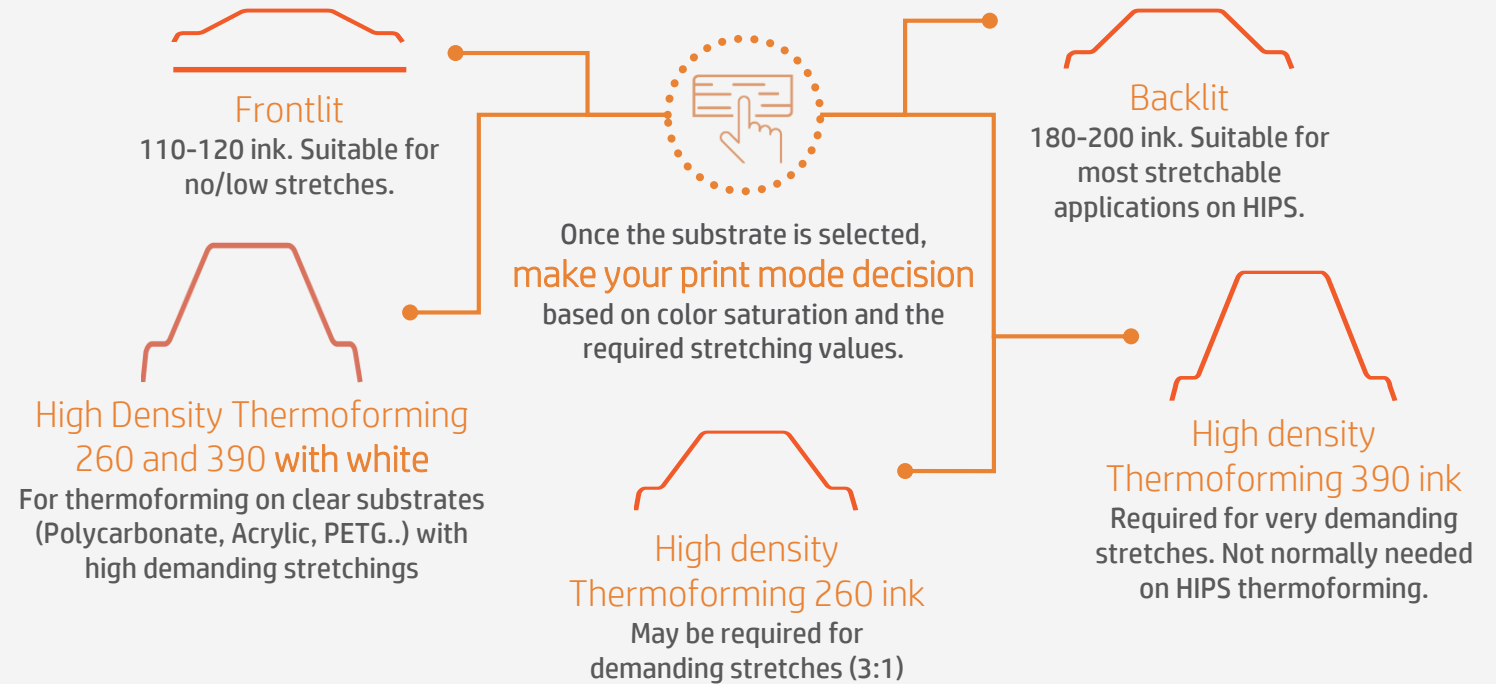

NOTES: When thermoforming a piece, the substrate becomes thinner, as does the ink layer. In order to support high stretching it is necessary to increase the ink load to prevent ink whitening. New high density thermoforming printmodes are available on Firmware revisions SKAAR_19_19_36.14 or higher.

→ To work with White, please refer to the cookbook "How to print on White".

The printing process

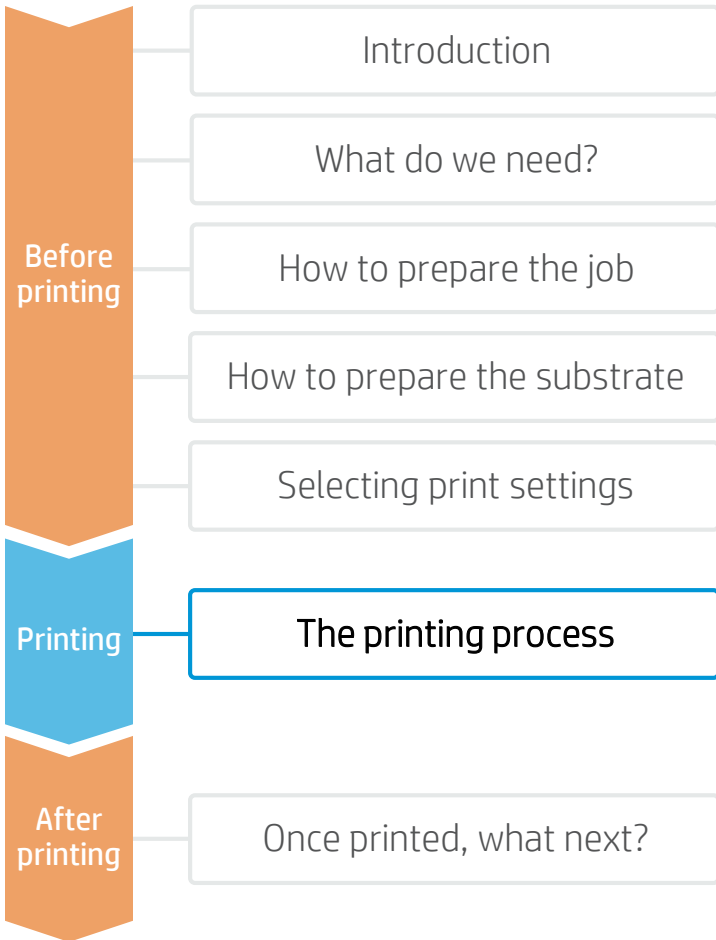

Rip the artwork after selecting the corresponding substrate preset and print mode for the HIPS boards. Send the output to the printer's nest.

Load the substrate on the printer as *Generic Plastic Solid*, *Generic Backlit Plastic Solid*, or using the specific preset previously downloaded.

Follow the loading process.

Select Heat Sensitive (HS) modes when printing 3mm boards or thinner.

Activate the HS lever if needed.

Select the ripped job and drag it to the printer queue.

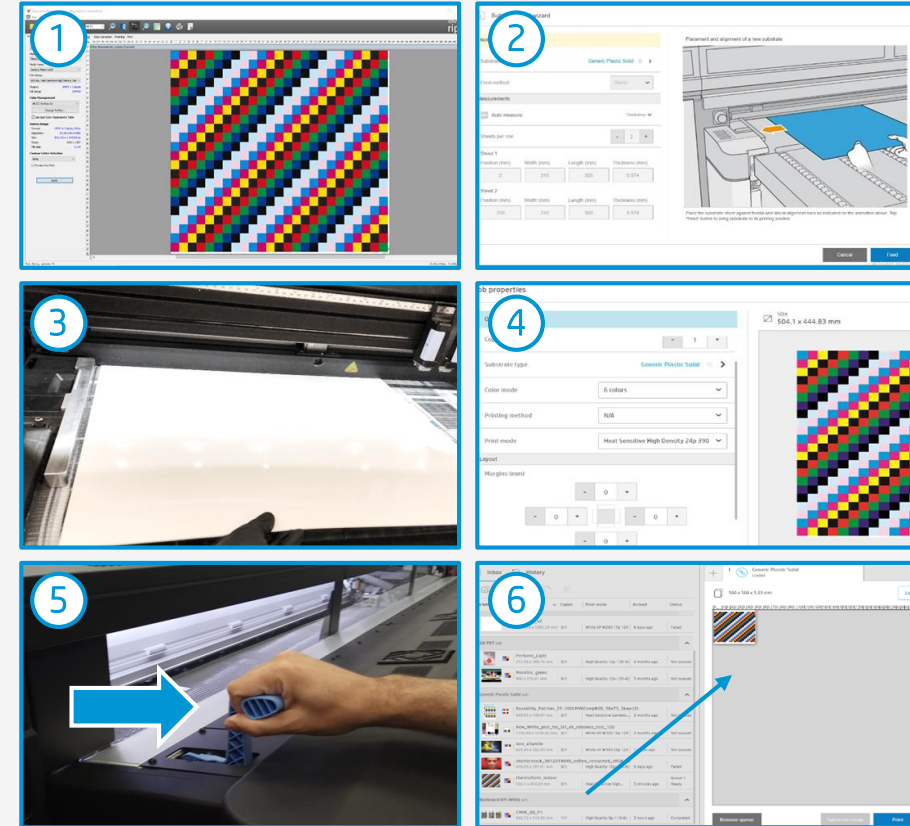

NOTE: We recommend using substrate edge holders when printing on boards wider than 1500mm/59", when printing on boards equal to or thinner than 3mm, or when printing on waved boards.

NOTE: Regarding printmode selection:

- Select "**Frontlit**" modes (110-120 ink) to print images that do not require stretching.
- Select "**Backlit**" modes (180-200 ink) for samples that will be back illuminated and for most stretched samples printed on HIPS.
- Select "**High density Thermoforming 260**" mode (260 ink) ink for very demanding stretches (3:1 draw ratio).
- "**High density Thermoforming 390**" mode (390 ink) provides the highest ink density. Normally this color saturation is not required to thermoform HIPS.



Vacuum Thermoforming on latex inks

Once printed, what next?

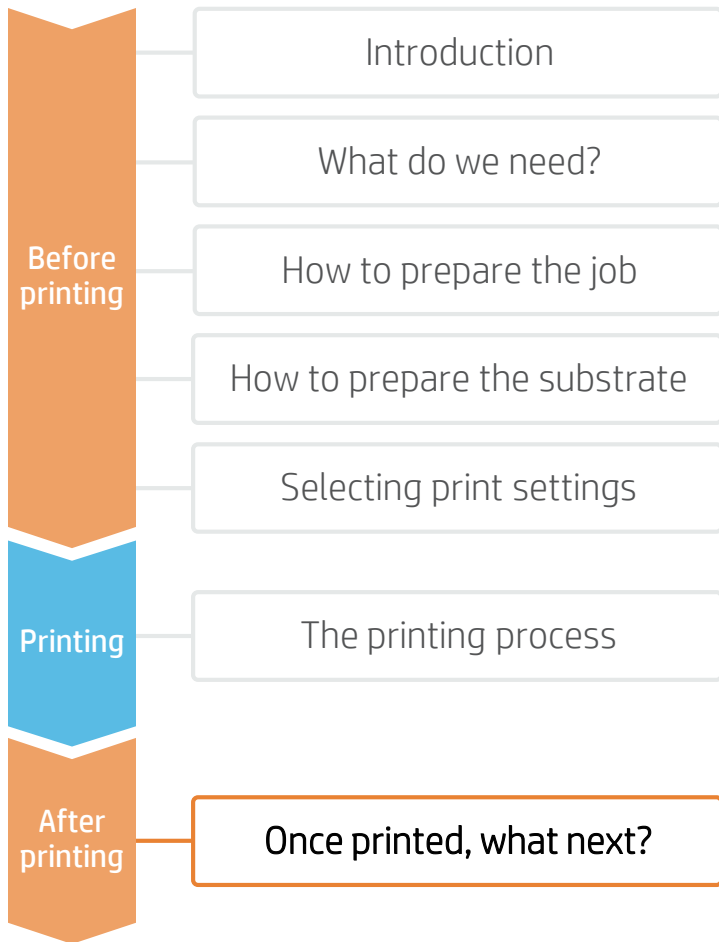

5.5 Handling Samples

HP recommends using gloves when handling samples immediately after printing, as the panels may be hot. Use caution when loading or lifting sheets from the tables, as the substrate and ink can be scratched.

NOTE: Ink adhesion may improve over 24 hours. However, it is possible to handle, machine, finish, and thermoform samples immediately after printing.



6. Protecting samples with a clear coat (optional)

To protect samples HP recommends applying an elastic coat prior to thermoform. We have successfully tested **Polymeric 25351 Clear Coat** on **HIPS** substrates.

Polymeric 25351 is a **2-component UV curable** clear coat that requires a catalyst (Part B) to gain full resistance. Follow application instructions:

Mixing: premix the 25351 **Part A** prior to pouring off enough to use in a 6-8h shift. Premix on medium shear for 5-10 minutes. Once Part A is mixed, prepare the amount to be used, then using a medium-to-high shear mixer place 3% (based on total weight) 25351 **Part B** into Part A and mix at medium shear for 10 minutes or until full incorporation.

Application: Polymeric 25351 is a roll coating clear coat with a 1-3 mil (25-75µm) recommended film thickness. Higher coat weights may show slight yellowing but should improve resistance properties.

Curing: Coating should be cured using a minimum of .250 J/cm² and .650 W/cm². A cross hatch tape test using 3M 600 or 610 tape can be performed once the part has cooled to room temperature. Delamination should be <5% at this moment.

Forming: Forming temperature should be set by the substrate manufacturer but should be a minimum of 350°F (176 °C). Heating above this temperature is required to achieve full durability

NOTE: After application it is recommended to clean the entire coating train, including the rollers, ink drip tray, and any auxiliary items that might have been in contact with the coating. Discard any clear coat Part A or B not used within the day. When not in use, keep all components out of direct light and covered. Recommended storage temperature is 40-90°F (4-32°C).

Vacuum Thermoforming on latex inks

Once printed, what next?

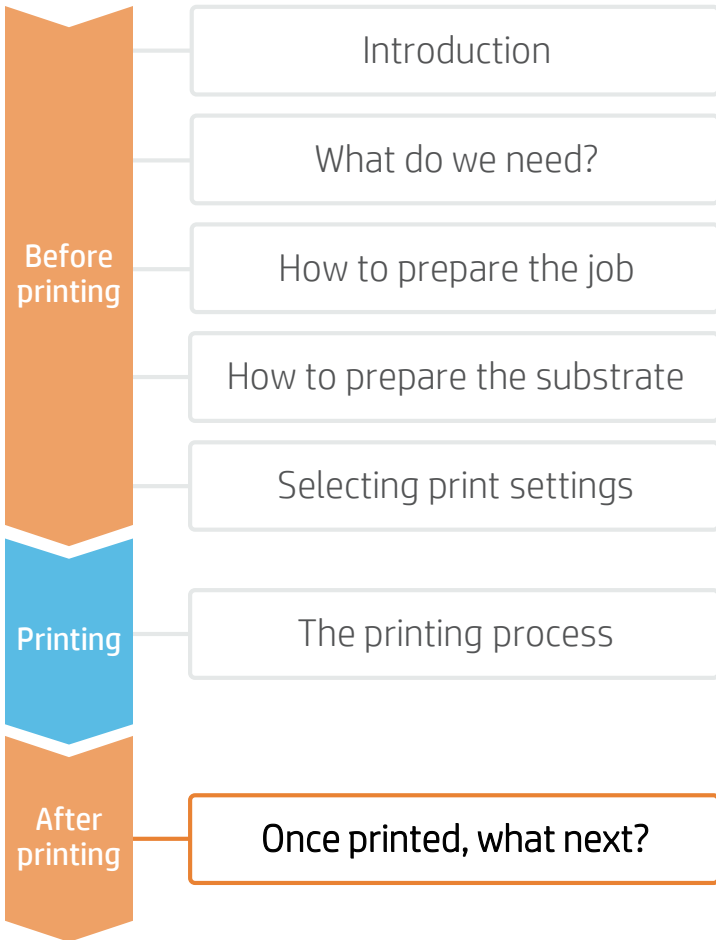

7. Forming

Once the sample is printed and protected we are ready to form the printed sheet.



7.1. Mold introduction

Move the molding base up and place the mold on it. Once the mold is on the base, lower the base using the thermoformer lever.

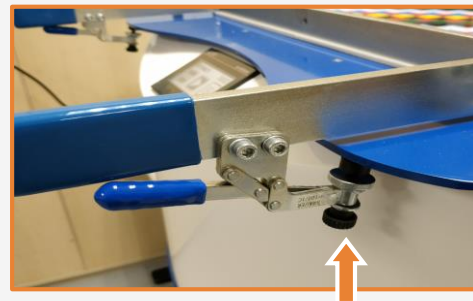

7.2 Clamping

Move the clamp up and introduce the sheet to be formed on the thermoformer frame. Ensure that the plastic seals on the frame are not damaged, as the vacuum will be lost if the seal has cracks.

Lower the clamp to secure the sheet. The clamp force needs to be strong enough to hold the plastic sheet during the forming process.

NOTES:

- Clamping force may need to be adjusted depending on the substrate thickness.
- Ensure you enable a proper registration method between the printed boards and the clamps to have consistent results.

Once printed, what next?

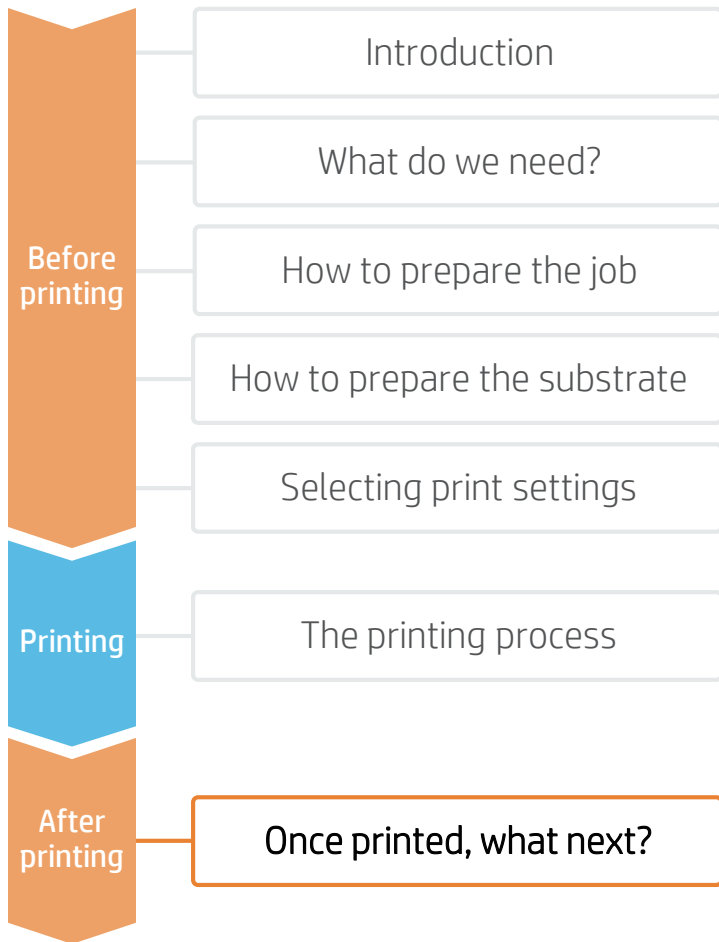

7.3. Sheet heating

Move the thermoformer's heater to the front and warm the sheet and mold. To obtain the best forming results, ensure that the heat is uniformly applied over its entire surface and through its thickness. When the sheet becomes heated it will start to sag.

Substrate	Glass transition temperature (Tg)	Recommended mold temperature	Recommended forming temperature	Drying temperature
PS, HIPS	94°C (201°F)	82°C (180°F)	150-175°C (302-347°F)	70°C (158°F)

HIPS thickness (mm/in)	Heat time (seconds)
1 / 0.04	30
1.5 / 0.06	45
2 / 0.08	60
3 / 0.125	90
4 / 0.16	120



NOTE: Heating times and temperatures depend on multiple factors: substrate, substrate thickness, and thermoformer used. We're sharing the recommended and tested forming settings for HIPS of Formech for its 508DT former.

7.4 Forming

Once the sheet is warm enough, move the heater back. Raise the mold using the lever. Vacuum is then applied to assist in forming the sheet. A vacuum pump is used to remove air trapped between the sheet and mold.

NOTE: In some cases, a pyrometer can be useful to determine board and mold temperature. By ensuring consistent temperatures (on molds, boards, and environmental conditions) we will be able to ensure consistent deformations.

NOTE: If the sheet has not been heated enough, the vacuum won't be able to get the desired definition. Increase sheet heating exposure time or increase forming temperature.



Once printed, what next?

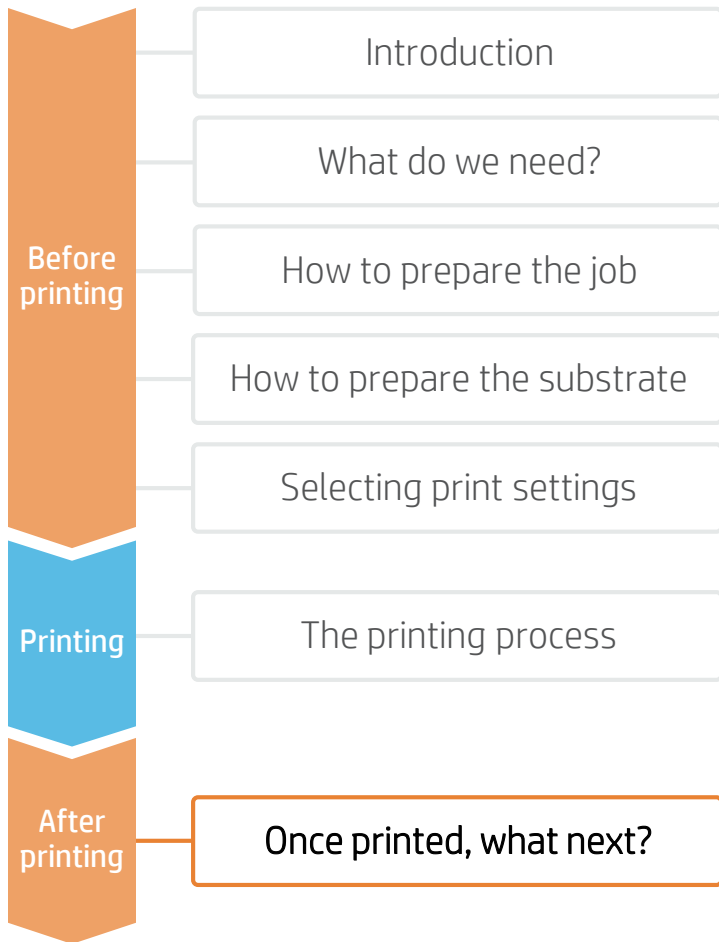

7.5 Cooling and release

Once formed, the plastic must be allowed to cool before being released. If the sample is released too early it will be deformed.

Once the sample is cool, press the release button to blow air between the sheet and mold. This will help the part to release.



NOTE: To help releasing samples from the mold, a demolding agent such as silicon oil can be used. If ink is in contact with mold, verify first if the ink is resistant to the release agent.

7.6 Trimming

Once the sample has been cooled and removed from the mold we can trim any material excess. The type of equipment required depends on the type of cut, part size and shape, sheet thickness...

Latex ink flexibility supports most cutting processes such as cut bands, cutting bits...

8. Cleaning

We recommend cleaning HIPS with a dry soft cloth. In case extra cleaning is needed, we recommend using water and a clean soft cloth only.

Clear coat protected samples can normally be cleaned with a variety of alcohol-based cleaners. Consult clear coat cleaning resistance.



Vacuum Thermoforming on latex inks

Learn more at:

www.hplatexknowledgecenter.com

Partnership:

RIPS and Print preparation:



QUADRAXIS

Finishing:



Legendary Performance





keep reinventing